



INDOOR BOARDS & CONNECTED COMPONENTS



OVERVIEW

AIR HANDLER BOARDS

- Model Nomenclature
- Board Components
- Wiring
- Commissioning

FURNACE BOARDS

- Model Nomenclature
- Board Components
- Wiring
- Commissioning

TROUBLESHOOTING



AT RUUD, WE'RE COMMITTED TO DOING WELL BY DOING GOOD.

OUR GLOBAL PROGRESS

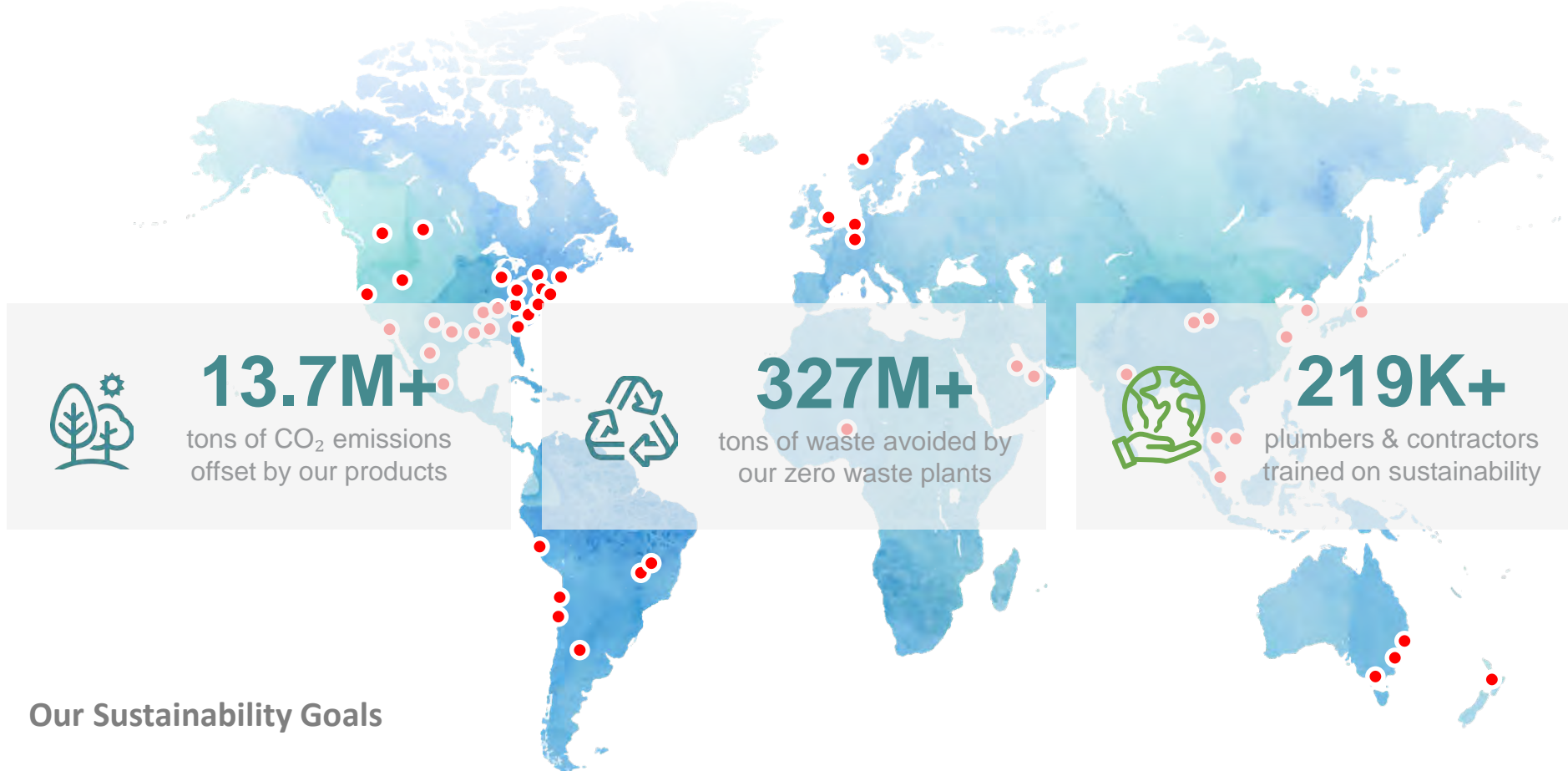

Our Sustainability Goals



DEGREES OF INNOVATION

Our 2025 goal: Launch a line of heating, cooling and water heating products that boast a 50% reduction in greenhouse gas footprint.



DEGREES OF EFFICIENCY

Our 2025 goal: Reduce greenhouse gas emissions by 50% and achieve Zero Waste to Landfill in our global manufacturing operations.



DEGREES OF LEADERSHIP

Our 2025 goal: Train 250,000 plumbers, contractors and key influencers on sustainable products or sustainable installation and recycling best practices.

Proudly Recognized
as a Sustainable Brand



2021 & 2022 ENERGY STAR
Partner of the Year



Eco-Leader for Five
Consecutive Years



Awarded for our Variable
Speed Heat Pump



A Greater Degree of Good™

represents our global commitment to sustainability. Look for this badge throughout the training!



EQUIPMENT OVERVIEW



WHY M1? DOE NEW EFFICIENCY STANDARDS

EFFECTIVE JAN 1, 2023, FOR NEW RESIDENTIAL AND SINGLE-PHASE LIGHT COMMERCIAL EQUIPMENT, <65K BTU/HR

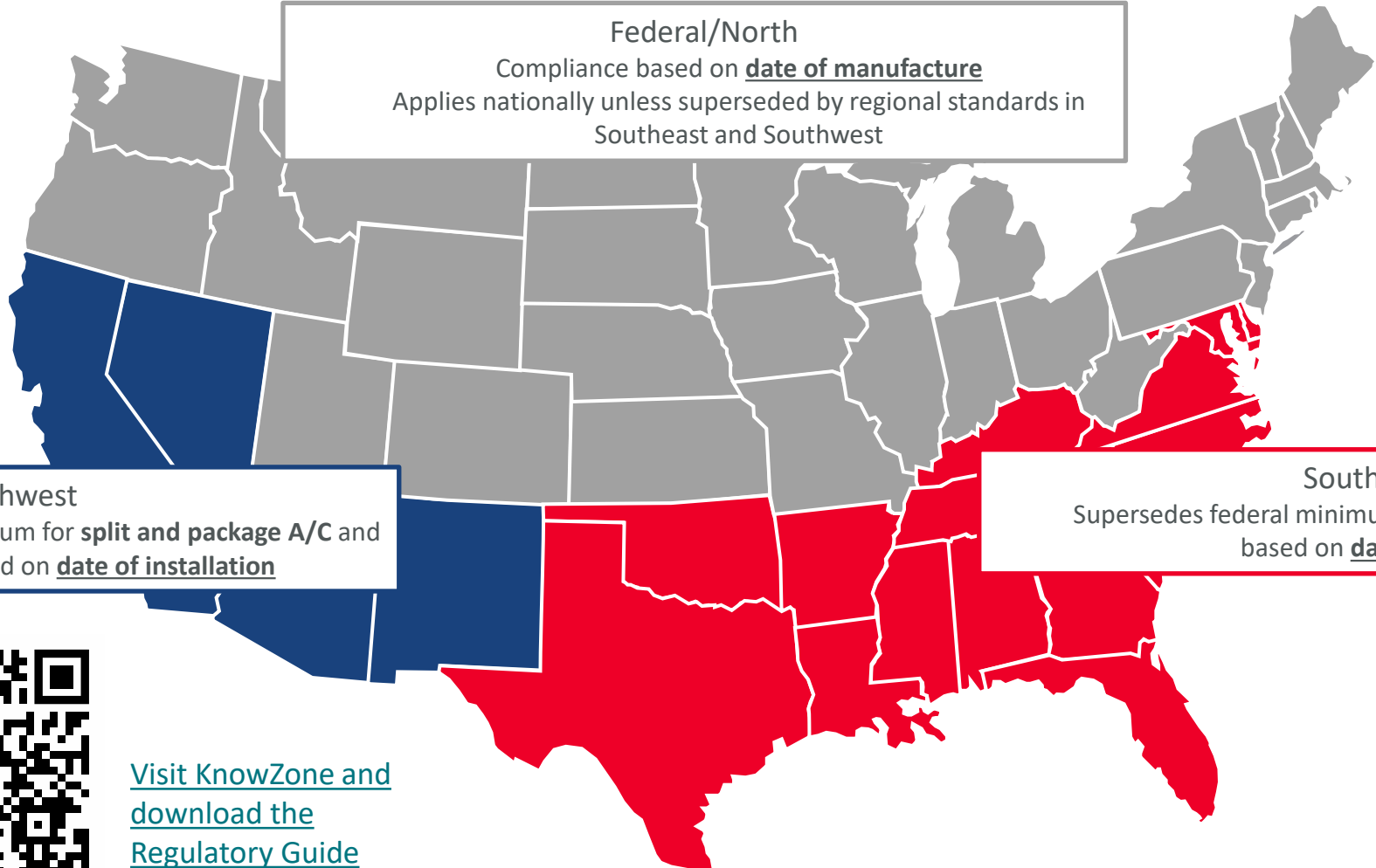

Federal/North
Compliance based on date of manufacture
Applies nationally unless superseded by regional standards in Southeast and Southwest

Southwest
Supersedes federal minimum for **split and package A/C** and compliance based on date of installation

Southeast
Supersedes federal minimum for **Split A/C** and compliance based on date of installation

Average
7-10%
efficiency
increase

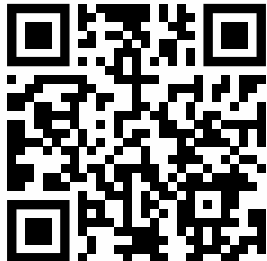

[Visit KnowZone and download the Regulatory Guide](#)



UNDERSTANDING REGIONAL STANDARDS

SOUTHEAST & SOUTHWEST

- No sell through
- Inventory manufactured prior to 1/1/2023: see [latest DOE guidance](#)
- Not applicable to heat pumps – national standard only
- Remember the rule of 3 – 2 – 1
 - *3 Different regional requirements for condensing units*
 - *2 Different requirements for package systems*
 - *1 National requirement for heat pumps*

PRODUCT CATEGORY	APPENDIX M1 REQUIREMENTS JANUARY 1, 2023						
	NORTH REGION		SOUTHEAST REGION		SOUTHWEST REGION		
	SEER2	HSPF2	SEER2	HSPF2	SEER2	EER2	HSPF2
SPLIT AC < 45k BTU/HR	13.4		14.3		14.3	11.7/9.8	
SPLIT AC ≥ 45k BTU/HR	13.4		13.8		13.8	11.2/9.8	
SPLIT HP	14.3	7.5	14.3	7.5	14.3		7.5
SINGLE Packaged AC/GE	13.4		13.4		13.4	10.6	
SINGLE Packaged HP	13.4	6.7	13.4	6.7	13.4		6.7



EXISTING INVENTORY

Compliance for Existing Inventory *AFTER JANUARY 1, 2023:*

Outdoor AC units manufactured prior to January 1, 2023, rated using Appendix M, can be installed in the Southeast and Southwest Regions, if the lowest FTC label rating (coil-only) is at or above the new minimum efficiency requirements on a conversion basis. Ratings based on Appendix M will need to be cross-referenced with the corresponding Appendix M1 values.

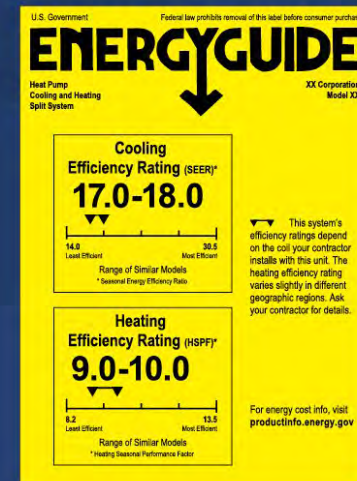



MAIN ENERGY INCREASE

CURRENT STANDARD: APPENDIX M

A/C Coil
Only
Rating

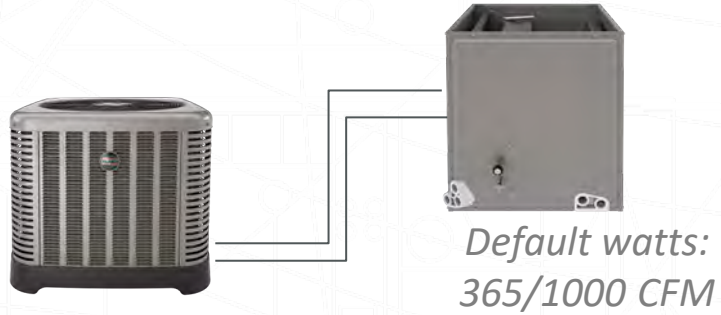

Mix-
Match
Rating



NEW STANDARD: APPENDIX M1

A/C Coil
Only
Rating

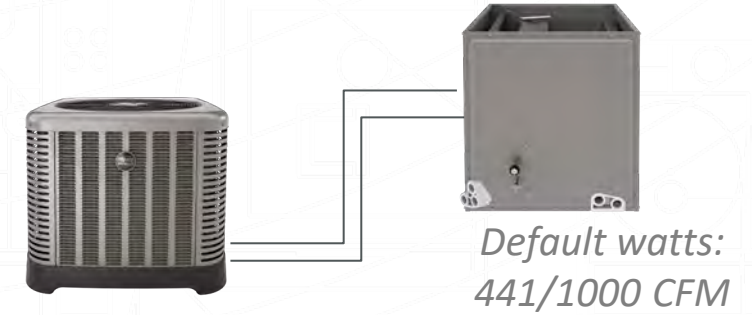

Mix-
Match
Rating













MODEL NOMENCLATURE – AIR HANDLERS

<u>R</u> Brand	<u>96</u> Product Category	<u>1</u> Stages of Air Flow	<u>P</u> Motor Type	NEW! <u>Z</u> Refrigerant	<u>24</u> Nominal Capacity	<u>17</u> Width	<u>S</u> Efficiency	<u>T</u> Metering Device	<u>N</u> Controls	<u>N</u> Coil Series	<u>J</u> Voltage	<u>**</u> Option Code
R = Ruud	96 = 96% AFUE	1 = One-Stage 2 = Two-Stage	P = PSC T = Constant Torque	Z = R-410A	18 - 18,000 BTU/H 24 - 24,000 BTU/H 30 - 30,000 BTU/H 36 - 36,000 BTU/H 42 = 42,000 BTU/H 48 = 48,000 BTU/H 60 = 60,000 BTU/H 65 = 65,000 BTU/H	17 = 17.5" Width 21 = 21" Width 24 = 24.5" Width	S = Standard M = Medium H = High	T = TEV	C = Communicating N = Non-communicating	A = A-coil N = N-coil	A = 115/1/60 D = 480/3/60 J = 208/240/1/60 T = 220/240/1/50	(See ADS-3803) Blank = None



2023+ TIERING | AIR HANDLERS



Air Handler Tier	Model	IDU Fan	
High	RHMVZ**C	Constant CFM / PWM	 
Mid	RH3VZ	Constant CFM / PWM	 
Base	RH2VZ	Constant CFM / PWM	 
	RH2TZ	Constant Torque	
	RH1PZ	PSC	
	RF1PZ	PSC	
	RF2TZ	Constant Torque	
		RB2TZ	Constant Torque













MODEL NOMENCLATURE - FURNACES

<u>R/U</u> Brand	<u>96</u> Furnace Efficiency	NEW! <u>2</u> Stages of Heating	<u>V</u> Motor Type	<u>040</u> Heating Input	<u>3</u> AC Max. Capacity	<u>A</u> Major Series	<u>17</u> Width	<u>M4</u> Position	<u>S</u> NOx	<u>C</u> Controls	<u>A</u> Minor Series	<u>P</u> Option Code
R/U - Ruud	80 – 80% AFUE 92 – 92% AFUE 95 – 95% AFUE 96 – 96% AFUE 97 – 97% AFUE 97 – 98% AFUE	1 – Single Stage 2 – Two Stage M – Modulating	T – Constant Torque V – ECM Variable Speed	040 - 40,000 [11.7 kW] 060 - 60,000 [17.6 kW] 070 - 70,000 [20.5 kW] 075 - 75,000 [22.0 kW] 085 - 85,000 [24.9 kW] 100 - 100,000 [29.3 kW] 115 - 115,000 [33.7 kW]	3 – 3 Ton Drive 4 – 4 Ton Drive 5 – 5 Ton Drive	A – 1 st Design Series B – 2 nd Design Series	14 – 14” Width 17.5 – 17.5” Width 21 – 21” Width 24 – 24” Width	M4 – Multi-4 Way UP – Upflow DZ – Downflow Zero Clearance UH – Upflow Horizontal DH – Downflow Horizontal	S – Standard N – Low NOx U – Ultra Low NOx	C – Communicating, EcoNet® Bluetooth® G – Communicating, EcoNet, No Bluetooth N – Non-communicating	A – 1 st Series B – 2 nd Series	P – Premium Grade S – Standard Grade



2023+ TIERING | FURNACE

Furnace Tier	Model	IDU Fan	Sustainability Standout*	
Prestige (High)	U98MV---P	ECM 3.0		 
	U97MV---P			
Classic Plus (Mid)	R962V---P	Constant CFM / PWM		 
	R802V---P*			
Classic (Base)	R951V---P	Constant CFM / PWM		 
	R921V---P			
	R801V---P*			
Classic (Builder)	R951T/R921T	Constant Torque		
	R801T	Constant Torque		



* Only the ULN models of these families are Sustainability Standouts



SUSTAINABILITY STANDOUT SEAL OVERVIEW

While many Rheem products have sustainable features, certain products stand out as a cut above—and those products earn the Sustainability Standout¹ seal.

It's given based on a number of internally designated factors relating to product attributes like energy efficiency, longevity, carbon reduction and more.

Look for the Sustainability Standout seal on marketing & training materials.

SUSTAINABILITY STANDOUT SEAL

While many Ruud® products have sustainable features, certain products stand out as a cut above—and those products earn the Sustainability Standout™ seal. It's given based on a number of internally designated factors relating to product attributes like energy efficiency, longevity, CO2 reduction and more. We're in the process of adding the seal in places including the product information pages, marketing and training materials—all to help professionals recommend responsible products and consumers make smart purchasing decisions.

HOW THE SEAL IS EARNED

To determine which products stand out among our sustainable offerings and have earned the right to bear the Sustainability Standout seal, we created a proprietary point system. In our Sustainability Strategy Sessions during our Product Development Process, we look at the Earth-friendly and user-friendly attributes of the product—such as efficiency, packaging, performance, features and recyclability. We assign each sustainability attribute a point value, and products that earn enough points bear the seal. Those that haven't earned enough points may still be very environmentally friendly. However, this seal is simply a way to make finding the best of the best easier.

SUSTAINABILITY STANDOUTS

We're working to bring the Sustainability Standout seal to all the products that qualify. Look for it on upcoming product pages, videos and other marketing materials to help you identify the product solutions that have earned a closer look.

RUUD.COM/SUSTAINABILITY

VIDEOS



Ruud.com/Progress



This product meets a stringent set of our internally defined sustainability standards



EFFICIENCY & SUSTAINABILITY BENEFITS OF RUUD'S 2023+ FURNACES

- **Superior energy efficiency** with 97% and 98% Annual Fuel Utilization Efficiency (AFUE) ratings
- **Reduced emissions and cleaner indoor air** with low- and ultra-low NOx models
- **Longer life** due to stainless steel heat exchanger* and constant CFM system
 - Lifetime unit replacement warranty available for Ultra and select Achiever Plus (RU962V) models
- **Flexible design** allowing for step-by-step upgrades vs. full system replacement
- **Bluetooth® connectivity and Ruud Contractor App**** to save time and truck rolls throughout installation, setup, and troubleshooting
- **EcoNet™ integration** for enhanced efficiency and control***

* Available in ultra-low NOx models

** Available in Classic & Classic Plus models

*** Available in Classic, Classic Plus, and Prestige models





BLUETOOTH® CONNECTIVITY



BLUETOOTH® BENEFITS

The Contractor App allows you to connect using Bluetooth technology and:

- Set up, diagnose, and repair HVAC products
- Sell and register HVAC products
- Verify and lookup warranties
- Access all the available product documents

Benefits:

- **Easier and faster installation** commissioning of units using Bluetooth®
- **Peace of mind**, fewer truck rolls, and faster repairs with remote diagnostics and troubleshooting
- **Convenient** registration and warranty signup
- **Streamlined units** with fewer components, and fewer tools (like pressure gauges) needed for onsite work

More information in the Contractor App Training

ATTENTION CONTRACTORS
APP REQUIRED FOR SYSTEM SETUP!

1. DOWNLOAD THE CONTRACTORS APP
Download App Here → 

2. CONNECT TO BLUETOOTH® TECHNOLOGY

FOR CONNECTION AND APP RELATED QUESTIONS, PLEASE CONTACT CUSTOMER SUPPORT AT: (800) 255-2388



Apple and App Store are registered trademarks of Apple Inc. Google Play is a service provided by Google LLC.

specitive owners.

7:15

Bluetooth® Setup

Which Product Do You Want To Connect To?

-  Air Handler
-  Furnace
-  Outdoor Unit

[I Don't See My Product](#)

[Cancel](#)





AIR HANDLER BOARDS



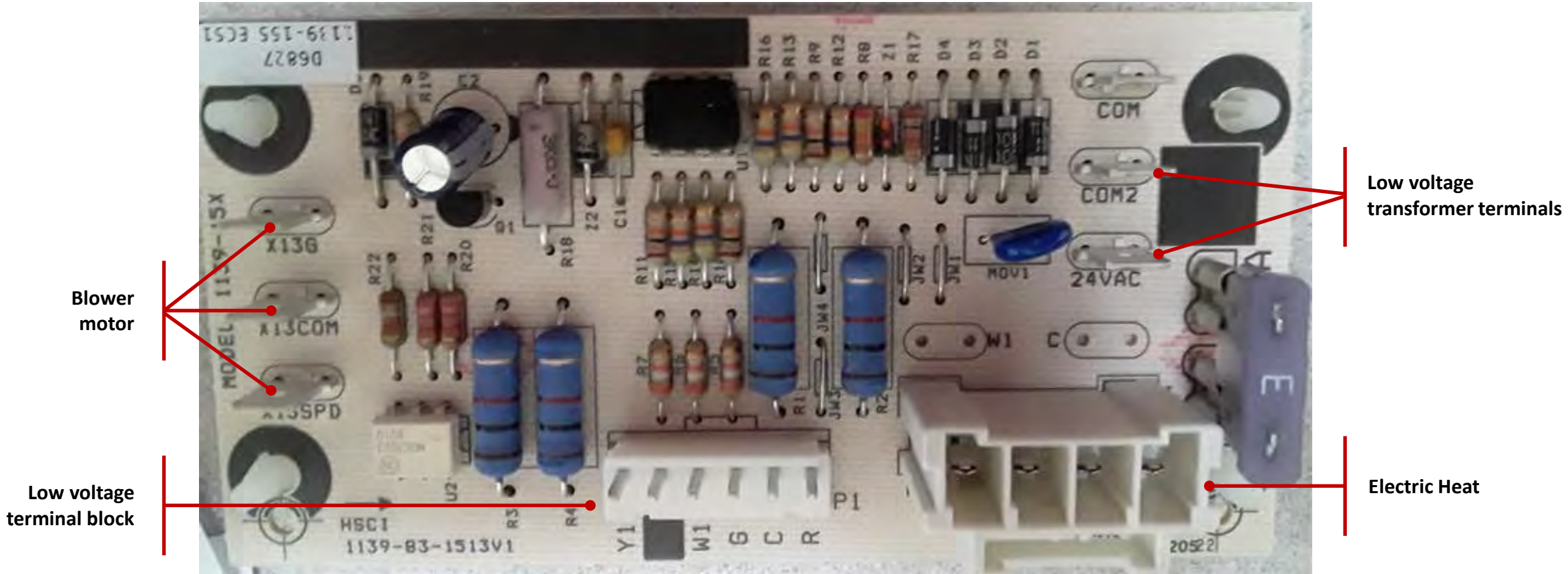

BASE-TIER AIR HANDLER BOARDS - RB2T, RF2T, RF1P, RH1P, RH2T





HEATER KIT ADAPTERS

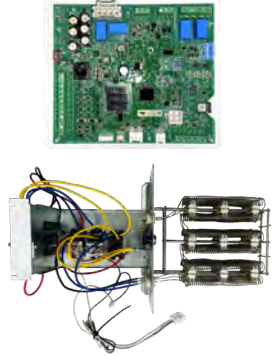
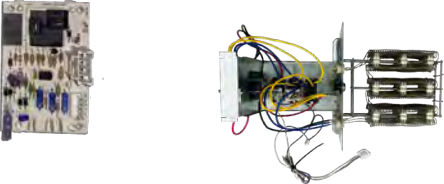
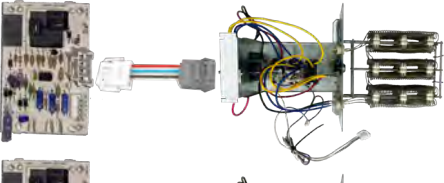
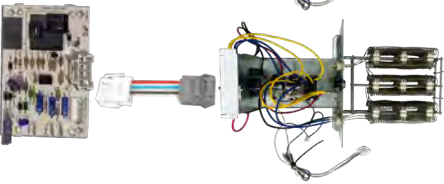

Air Handler Model	Compatible Heater Kits	Control, Kit combinations	
(-)RHMVZ**C	RXBH Series with suffix -B		
(-)RH3VZ	RXBH Series with suffix -B		
(-)RH2VZ	RXBH Series with suffix -B		
(-)RH2TZ	RXBH Series with suffix -1		New board + new kit or
(-)RH1PZ	RXBH Series with suffix -1		
(-)RF1PZ	RXHJ Series with suffix -1		or
(-)RF2TZ	RXHJ Series with suffix -1		New board + old kit with adapter 45-106229-05



MID-TIER & HIGH-TIER AIR HANDLER BOARD – RH2V, RH3V, RHMV

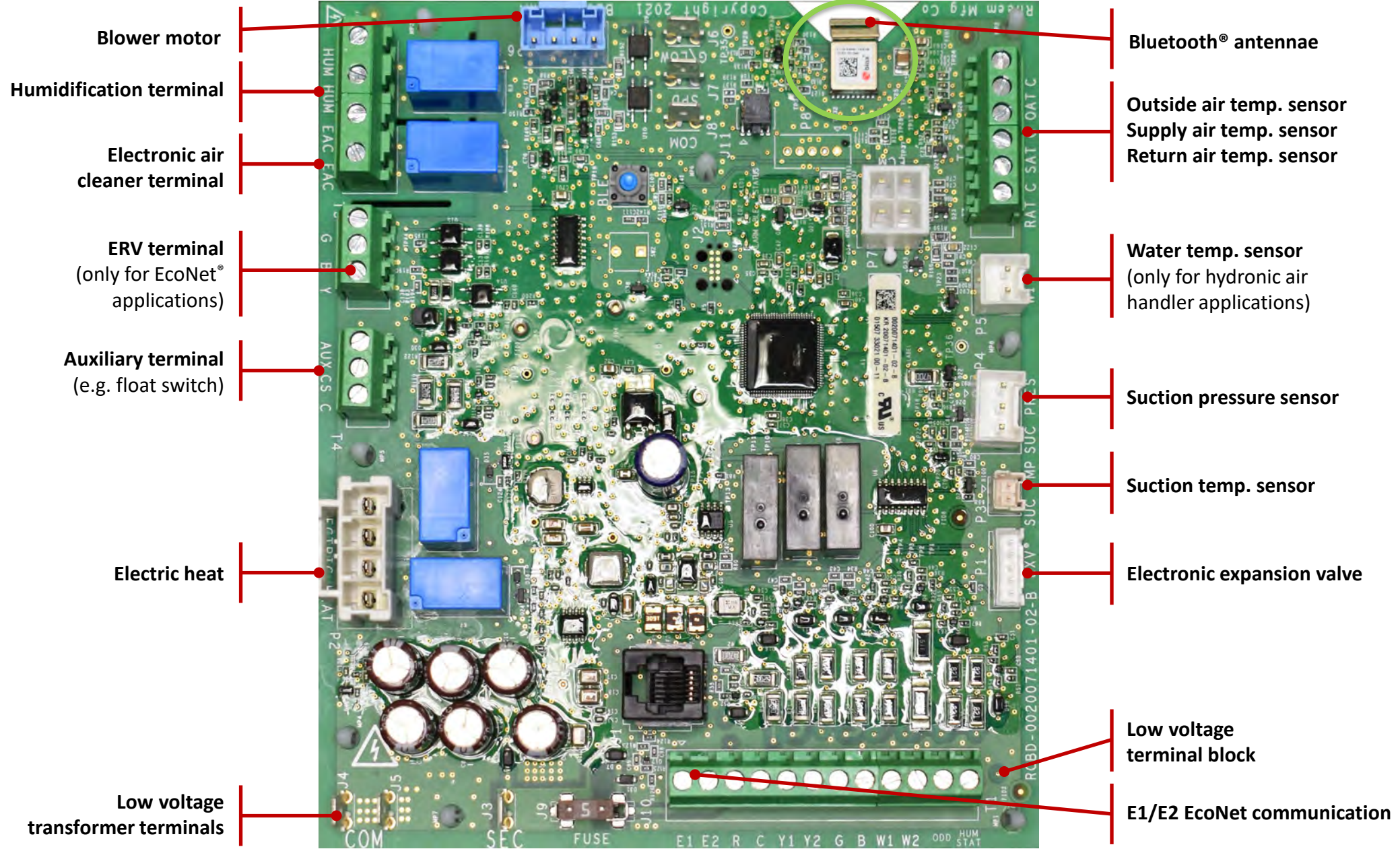



CONTROLS INPUTS & OUTPUTS

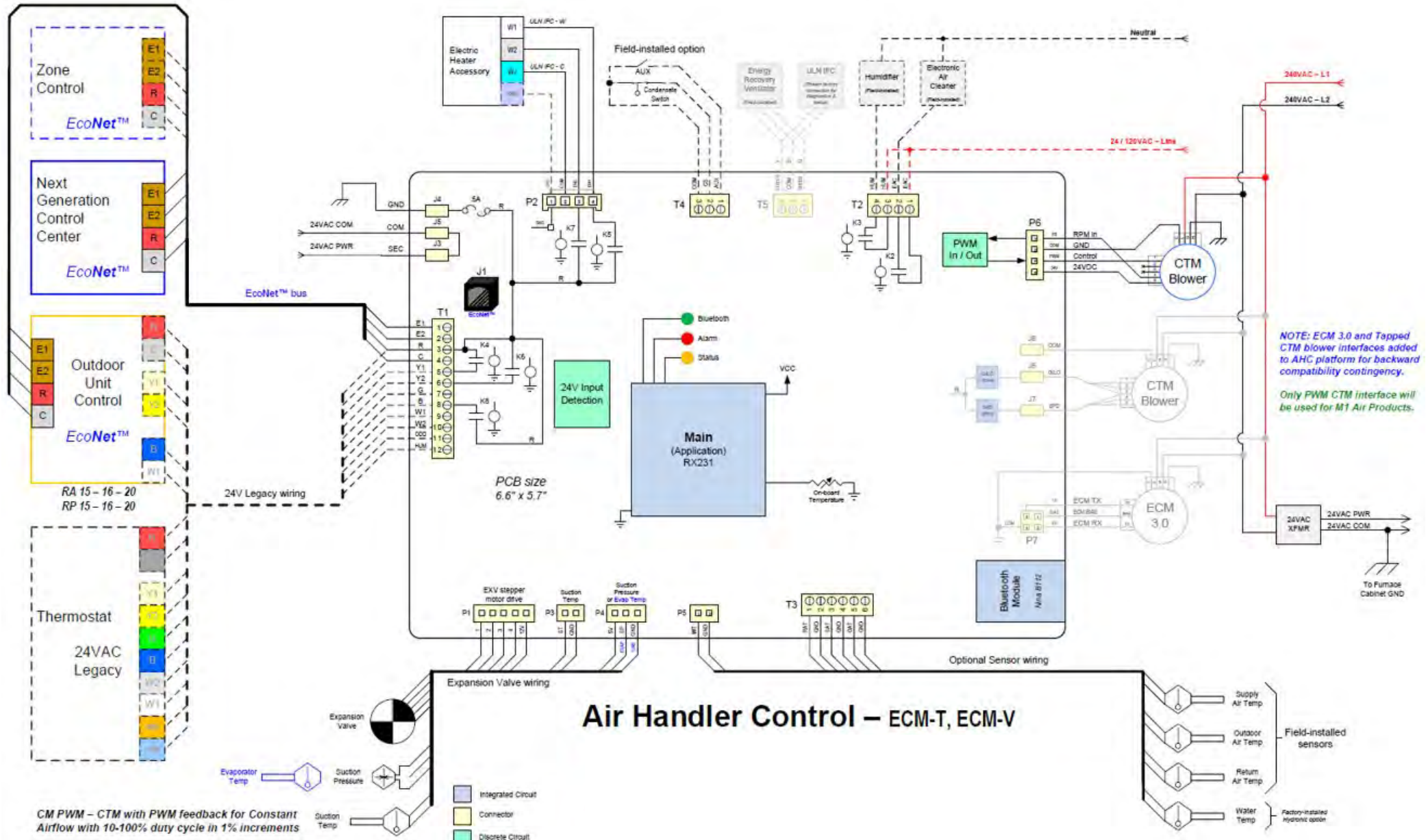

Air Handler Control – ECM-T, ECM-V



THERMOSTAT WIRING – ECONET[®] SMART THERMOSTAT

- **NEW!** Removeable low voltage terminal block on the thermostat wiring
- Requires continuous 18 AWG thermostat wire.
 - Do not use phone cord to connect indoor and outdoor units. This will damage the controls.
- The EcoNet[™] control system requires four (4) control wires for unit operation:
 - R 24 VAC
 - C 24 VAC common
 - E1 Communications
 - E2 Communications
- The EcoNet[®] enabled air handler or furnace is equipped with a 24-volt, 40 or 50 VA transformer for proper system operation.

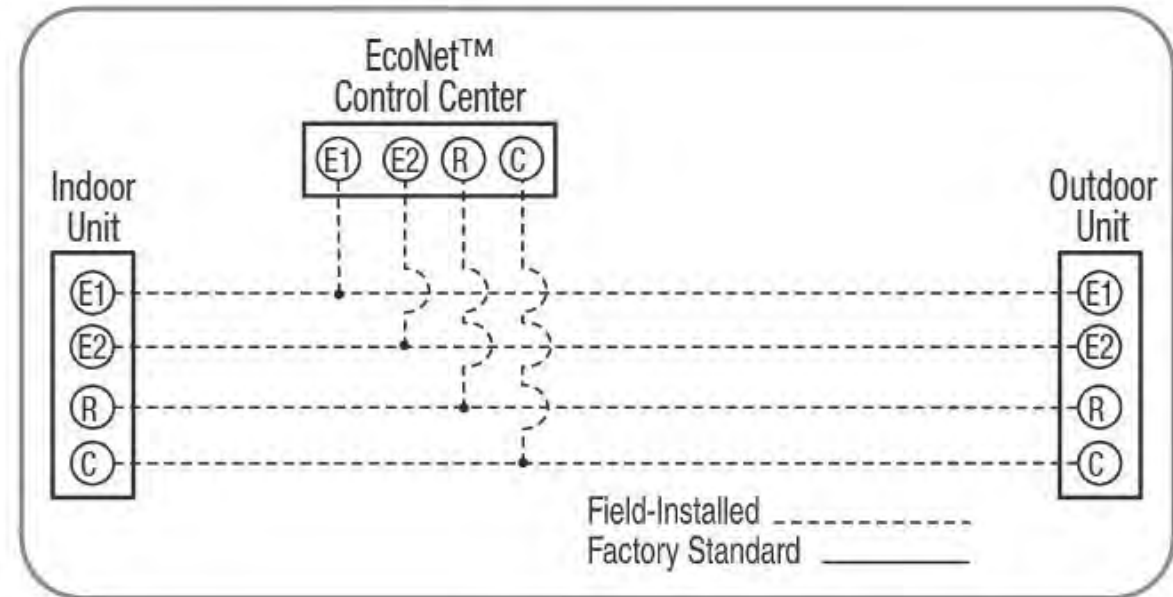



THERMOSTAT WIRING – LEGACY (24V) THERMOSTAT

- **NEW!** Removeable low voltage terminal block on the thermostat wiring
- Thermostat control wiring requires a minimum of six (6) wires for proper heat pump operation and five (5) wires for proper AC operation:
 - R – 24 VAC (AC/HP)
 - C – 24 VAC common (AC/HP)
 - G – Indoor fan (AC/HP)
 - Y1 – 1st stage compressor (AC/HP)
 - Y2 – 2nd stage compressor (AC/HP)
 - B – Heat pump operation (HP)
 - W – Supplemental heat during defrost cycle (AC/HP)

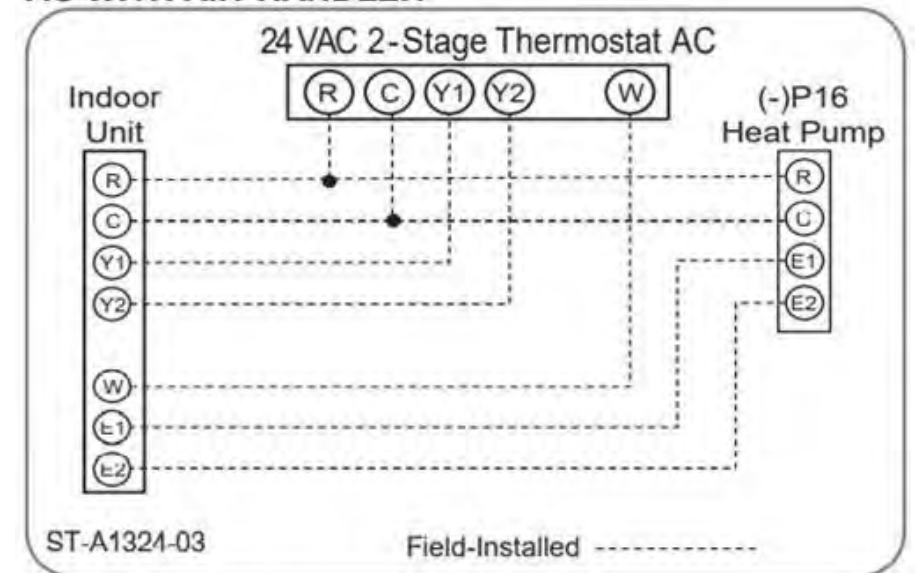
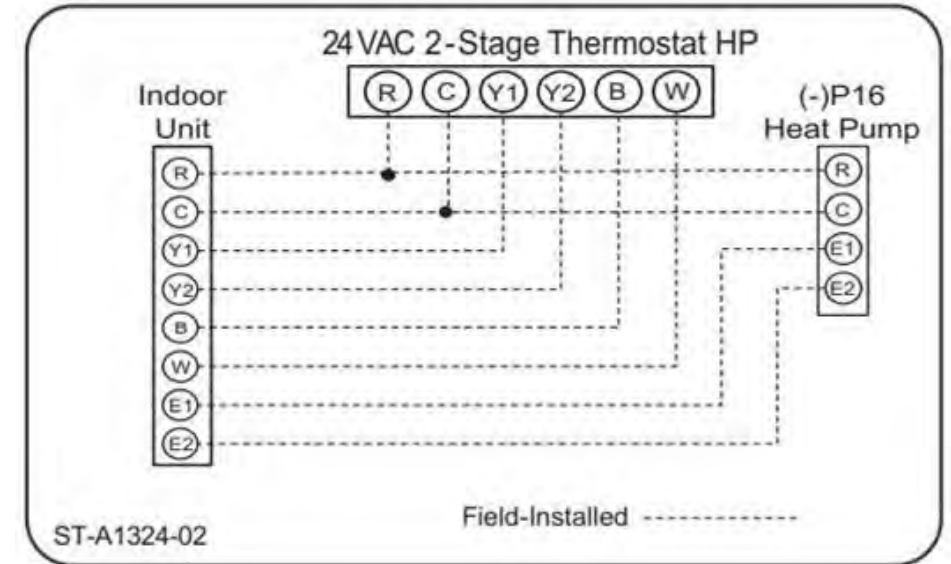



COMMISSIONING AIR HANDLER: ECONET® SMART THERMOSTAT

- No extra setup required...
 - With fully communicating system
 - For non-communicating ODU matchup, must select tonnage and stages
- You can further refine comfort settings. For example,
 - Auxiliary Switches
 - EXV Superheat Setpoint

Note: You can configure the EXV Superheat Setpoint only if the EXV input is detected on the control board.
- These adjustments can only be made at the EcoNet Smart Thermostat
- **NEW!** EcoNet now autodetects the heater kit



Air Handler Settings		
Electric Heater Size		3 KW
		Airflow 2 600 C
Electric Heat Airflow Select		0 F
G Input Fan Control		High
Condensate Input	N.O.	Off
Aux Config	N.O.	Off
Filter Type		Media
<BACK		



COMMISSIONING AIR HANDLER: LEGACY THERMOSTAT

- With the Contractor App...
 - System will detect a communicating ODU
 - System will detect a non-communicating ODU and require additional selections
 - Outdoor Unit Stages
 - Outdoor Unit Tonnage
- Can further refine comfort settings after system is connected
- If you install a unit, but for some reason can't configure it, the system will use the "default" model data from the board that was programmed at the factory.
 - It will be the highest nominal airflow for that unit. (e.g., for a 6024, it would be 5 ton)
 - Not recommended; the system will not be optimized for all installation configurations
- If pairing air handler with an 18 SEER2 unit, the system will operate at a fixed speed (100%).
 - Variable speed will not be available.

*except RA15, UA16, UP16 which have to be wired communicating to indoor unit

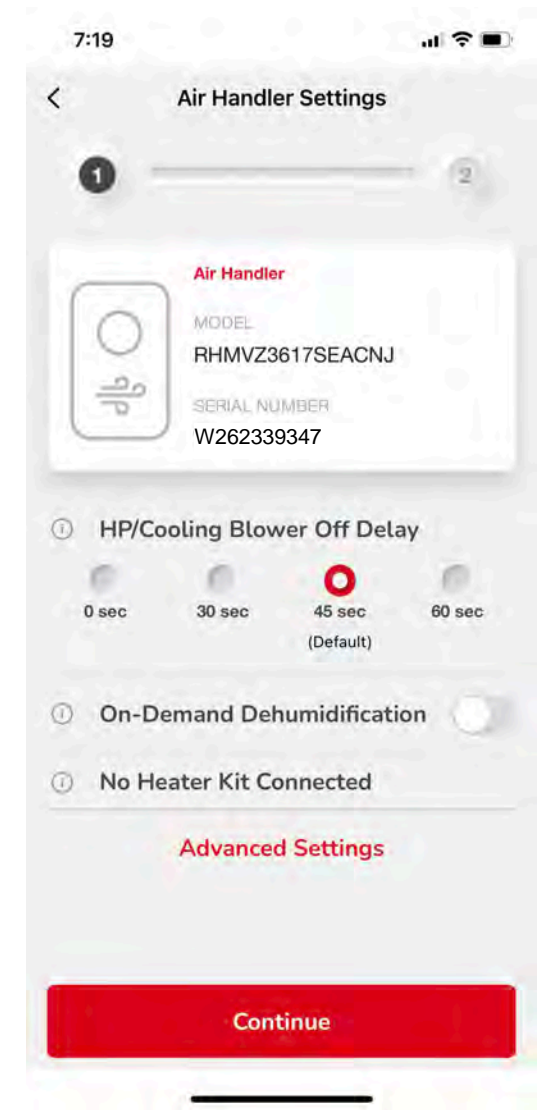



HEATER KITS

Heater Kit Connectors

- In the new heater kits, there are new connectors that allow the EcoNet-enabled board to automatically recognize and setup heater kits
- If the connection is interrupted, there is an alert.
- If the connector fails, the heater kit will not operate, there will be a loss of emergency heat operations.

Auto-Detected Heater Kits

- If the wrong heater kit is displayed (in the Contractor App or EcoNet® Smart Thermostat), the contractor must take action to install the correct heater kit.
 - The airflow and heat rise will be incorrect
- If the heater size is “0” (which is what would be seen if there was an invalid heater kit), the model data is used for airflows. The model data should be the highest airflows for that air handler.

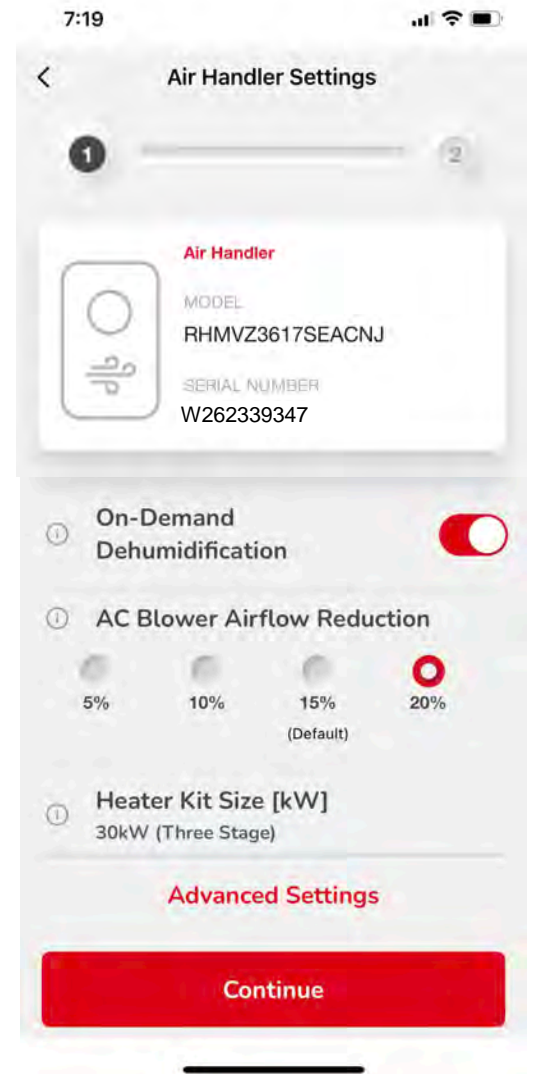



FLOAT/CONDENSATE SWITCH (CS)

- New wiring for float switches
- Use CS and C to wire float switch
- Properly wiring float switch will allow full alarm capability
 - EcoNet® Thermostat will show an alarm
 - This will cause a system shutdown until the issue is resolved

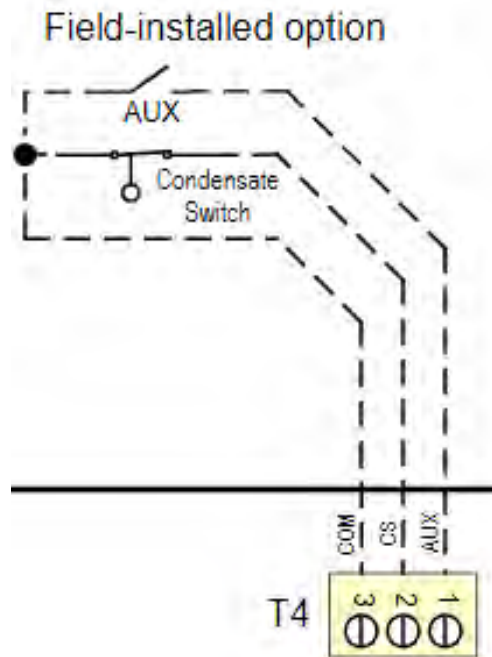

Air Handler Settings		
Electric Heater Size		3 KW
		Airflow 2 600 CFM
Electric Heat Airflow Select		0 F ▲
G Input Fan Control		High
Condensate Input	N.O.	Off ▼
Aux Config	N.O.	Off
Filter Type		Media
<BACK		

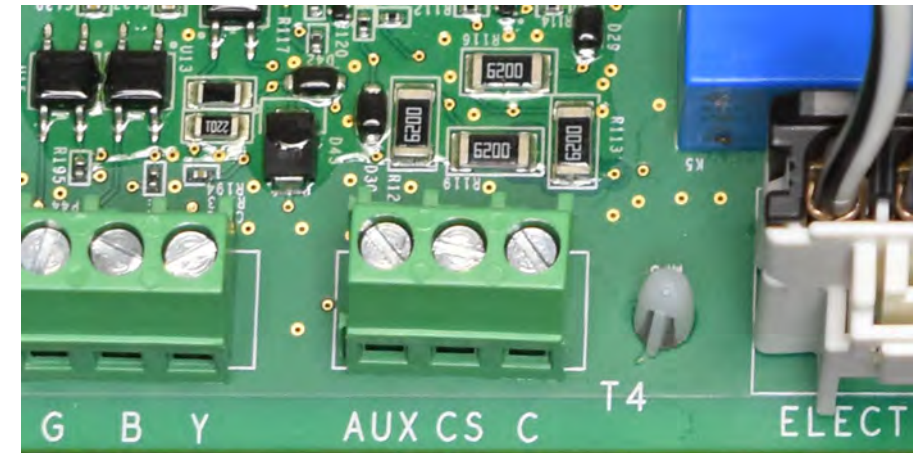



SEQUENCE OF OPERATION (LEGACY) – COOLING

Call for Cooling

1. Place a call for cooling.
2. The contacts between terminals R, Y1, and G of the thermostat will close.
3. With 24V applied to the Y1, the constant volume motor interface control board will apply control voltage to the constant volume blower motor.
4. The blower motor will now operate.
 1. Y1 signal when wired with legacy wiring
 2. E1/E2 signal when wired with mid-tier inverters

Terminate Call for Cooling

1. Terminate the call for cooling.
2. The outdoor unit will turn off.
3. The constant volume blower motor will continue to operate for 30 seconds before stopping operation.





SEQUENCE OF OPERATION (LEGACY) – FAN

Call for Fan

1. Place a call for fan.
2. The contacts between terminals R and G of the thermostat will close, applying 24V to the G terminal of the constant volume motor interface control board
3. With 24VAC applied to the G terminal, the constant volume motor interface control board will apply control voltage to the constant volume blower.
4. The blower motor will now operate.

Terminate Call for Fan

1. Terminate the call for fan.
2. The contacts between terminals R and G of the thermostat will open, removing 24V to the G terminal of the constant volume motor interface control circuit board.
3. The constant volume blower motor will stop operation with no off-time delay.



SEQUENCE OF OPERATION (LEGACY) – EMERGENCY HEAT

Call for Emergency Heat

1. Place a call for emergency heat.
2. The thermostat will apply 24V to terminal W1 (optional W2 or emergency heat on legacy thermostats).
3. The blower motor will now operate.
4. 24V will also be applied to the electric heater relay coils via the 4-pin plug.
5. After a time delay the heater kit is energized.

Terminate Call for Emergency Heat

1. The thermostat turn off emergency heat call.
2. The thermostat will remove 24V from terminal W1 (optional W2 or emergency heat on legacy thermostats).
3. The blower motor turn off.
4. 24V will also be removed from the electric heater relay coils via the 4-pin plug.
5. After a 90 second blower off delay, the emergency heat will turn off.



FURNACE BOARDS



BASE TIER - FURNACE CONTROL

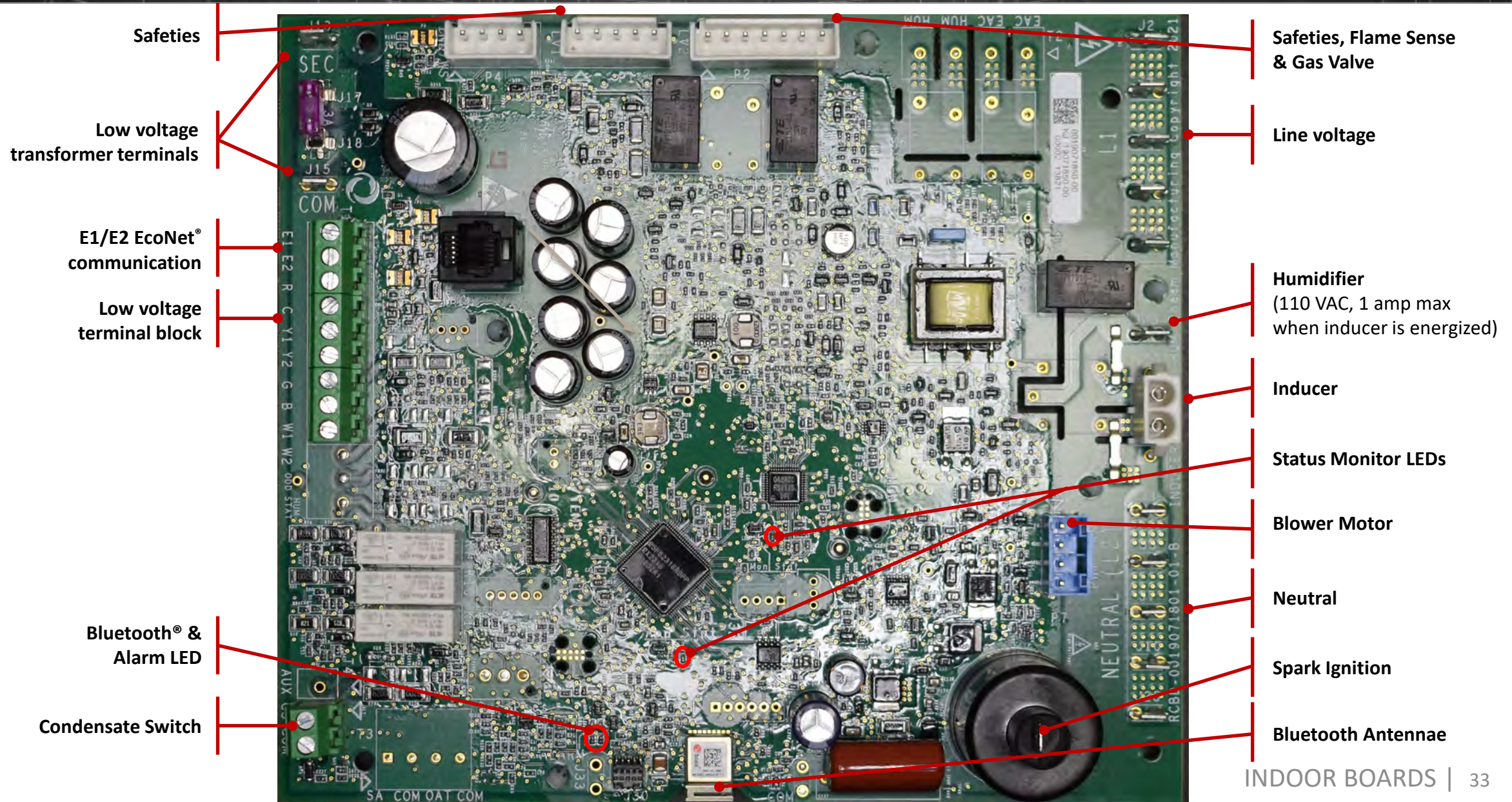



WIRING DIAGRAM - (-)801V ***P (SINGLE STAGE 80+)

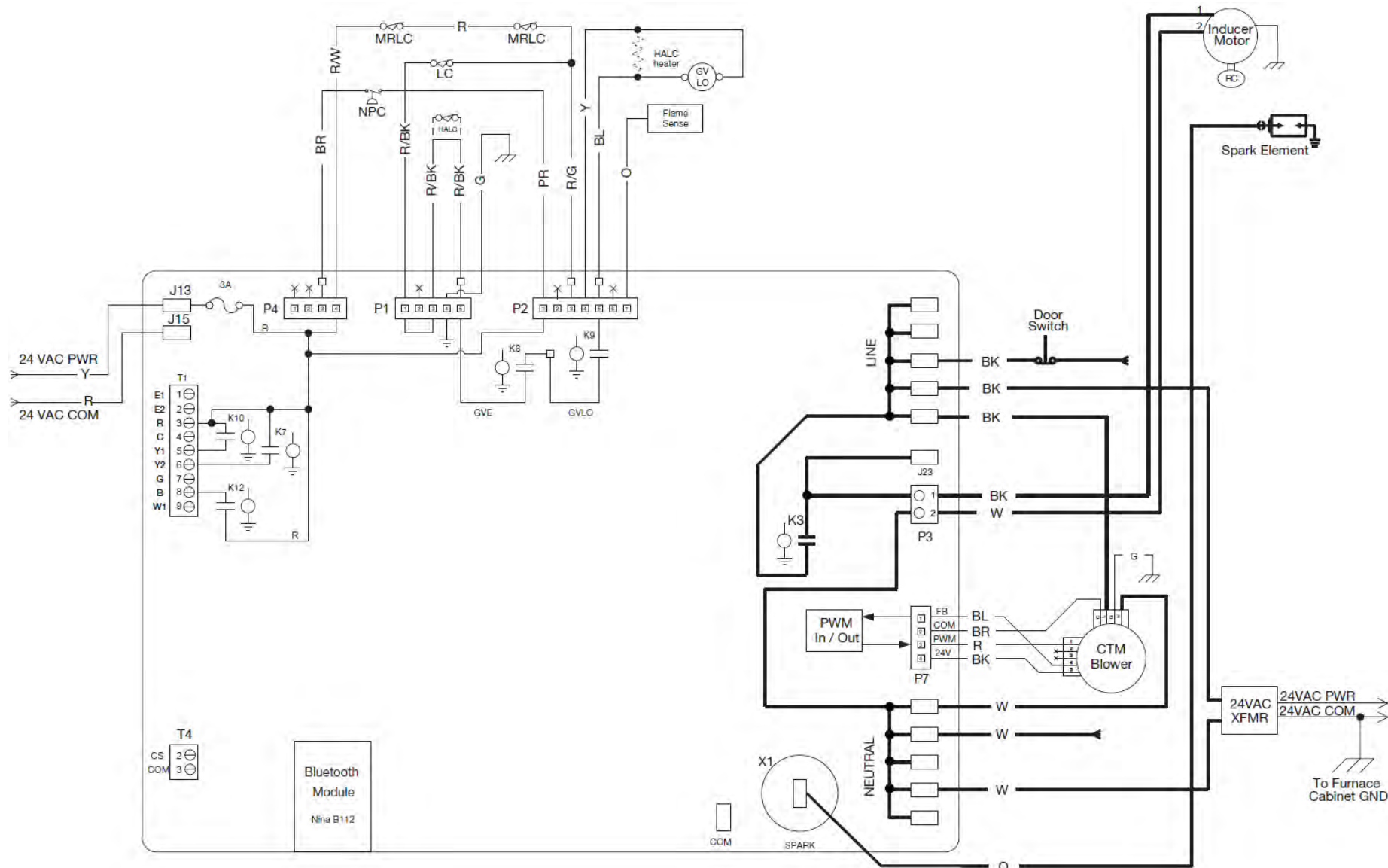

WIRING INFORMATION

- LINE VOLTAGE
 -FACTORY STANDARD
 -FACTORY OPTION
 -FIELD INSTALLED
- LOW VOLTAGE
 -FACTORY STANDARD
 -FACTORY OPTION
 -FIELD INSTALLED

COMPONENT CODES

- | | | |
|--------------|-----------------------------|---------------|
| BLWR | BLOWER RELAY | |
| C | COMMON | |
| CC | COOLING CONTACTOR | |
| CS | CONDENSATE SWITCH | |
| CT | CONTROL TRANSFORMER | |
| DISC | DISCONNECT SWITCH | |
| EAC | ELECT. AIR CLEANER OUTPUT | |
| FLMS | FLAME SENSOR | |
| FR | FAN RELAY | |
| FU | FUSE | |
| GND | GROUND | |
| GVR | GAS VALVE RELAY | |
| HALC | HEAT ASSISTED LIMIT CONTROL | |
| HCR | HEAT/COOL RELAY | |
| HPC | HIGH PRESSURE CONTROL | |
| HUM | HUMIDIFIER OUTPUT | |
| IBM | INDOOR BLOWER MOTOR | |
| IDM | INDUCED DRAFT MOTOR | |
| IDR | INDUCED DRAFT RELAY | |
| | | |
| IFC | INTEGRATED FURNACE CONT. | |
| LC | LIMIT CONTROL | |
| LPC | LOW PRESSURE CONTROL | |
| M | MAIN | |
| MC | MEMORY CARD | |
| MGV | MAIN GAS VALVE | |
| MRLC | MAN. RESET LIMIT CONTROL | |
| NEU | NEUTRAL | |
| NPC | NEGATIVE PRESSURE CONT. | |
| PBS | PUSH BUTTON SWITCH | |
| PFC | POWER FACTOR CHOKE | |
| PL | PLUG | |
| PS | PRESSURE SWITCH | |
| RC | RUN CAPACITOR | |
| SE | SPARK ELECTRODE | |
| TM | THERMISTOR | |
| ⚡ | WIRE NUT | |
| | | |
| BK.....BLACK | G.....GREEN | PR.....PURPLE |
| BR.....BROWN | GY.....GRAY | R.....RED |
| BL.....BLUE | O.....ORANGE | W.....WHITE |
| | | Y.....YELLOW |



WIRING DIAGRAM – (-)951V, (-) 921V (SINGLE STAGE 90+)

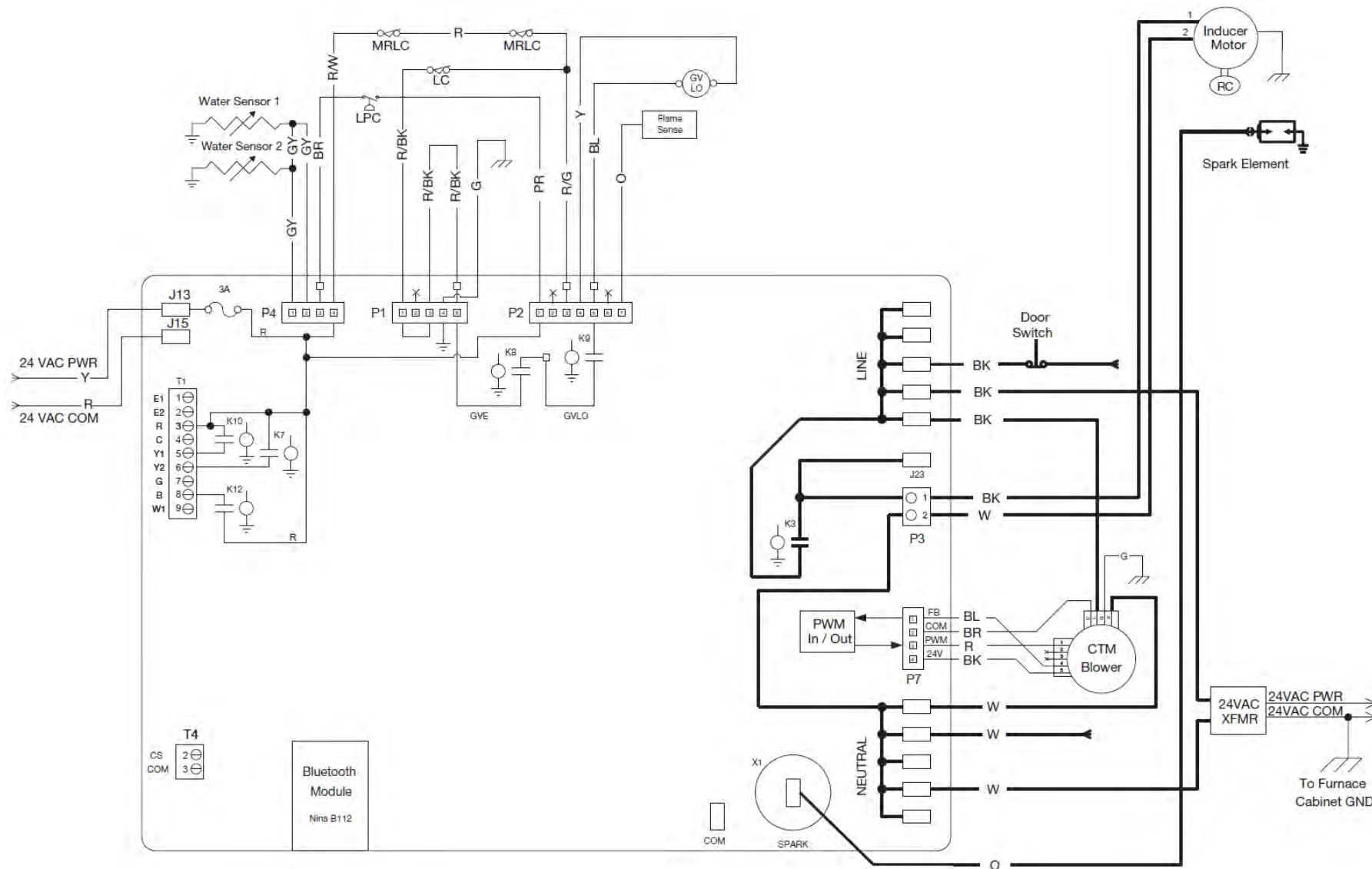

WIRE COLOR CODE

BK.....BLACK	G.....GREEN	PR.....PURPLE
BR.....BROWN	GY.....GRAY	R.....RED
BL.....BLUE	O.....ORANGE	W.....WHITE
	Y.....YELLOW	

WIRING INFORMATION

LINE VOLTAGE

- FACTORY STANDARD
- FACTORY OPTION
- FIELD INSTALLED

LOW VOLTAGE

- FACTORY STANDARD
- FACTORY OPTION
- FIELD INSTALLED

COMPONENT CODES

BLWR	BLOWER RELAY
C	COMMON
CC	COOLING CONTACTOR
CT	CONTROL TRANSFORMER
DISC	DISCONNECT SWITCH
EAC	ELECT. AIR CLEANER OUTPUT
FLMS	FLAME SENSOR
FR	FAN RELAY
FU	FUSE
GND	GROUND
GVR	GAS VALVE RELAY
HALC	HEAT ASSISTED LIMIT CONTROL
HCR	HEAT/COOL RELAY
HPC	HIGH PRESSURE CONTROL
HUM	HUMIDIFIER OUTPUT
IBM	INDOOR BLOWER MOTOR
IDM	INDUCED DRAFT MOTOR
IDR	INDUCED DRAFT RELAY
IFC	INTEGRATED FURNACE CONT
LC	LIMIT CONTROL
LPC	LOW PRESSURE CONTROL
M	MAIN
MC	MEMORY CARD
MGV	MAIN GAS VALVE
MRLC	MAN. RESET LIMIT CONTROL
NEU	NEUTRAL
NPC	NEGATIVE PRESSURE CONT.
PBS	PUSH BUTTON SWITCH
PFC	POWER FACTOR CHOKE
PL	PLUG
PS	PRESSURE SWITCH
RC	RUN CAPACITOR
SE	SPARK ELECTRODE
TM	THERMISTOR
WS	WATER SENSOR
⌚	WIRE NUT



MID-TIER - FURNACE CONTROL

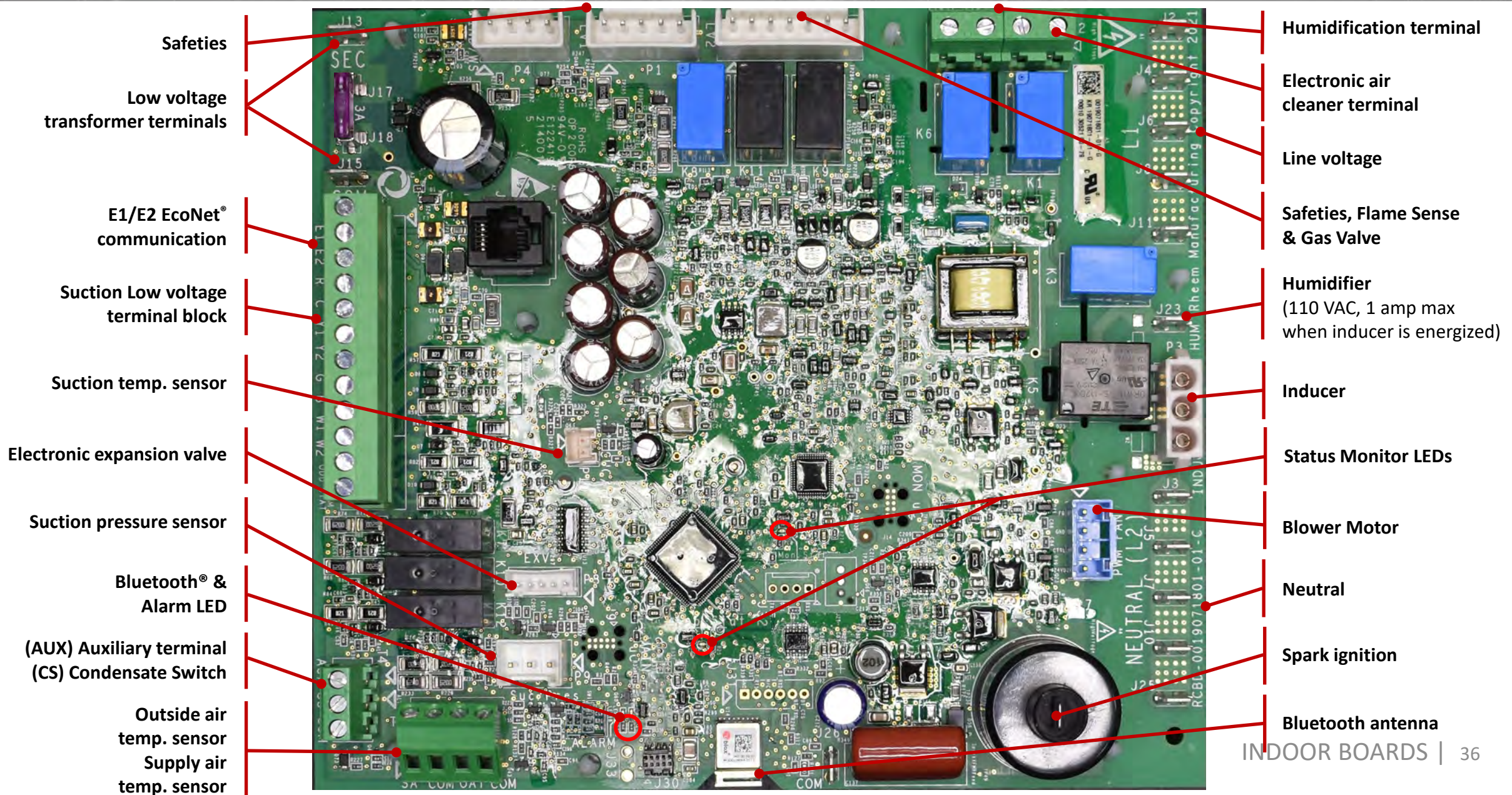



WIRING DIAGRAM – (-)802V (TWO STAGE 80+)

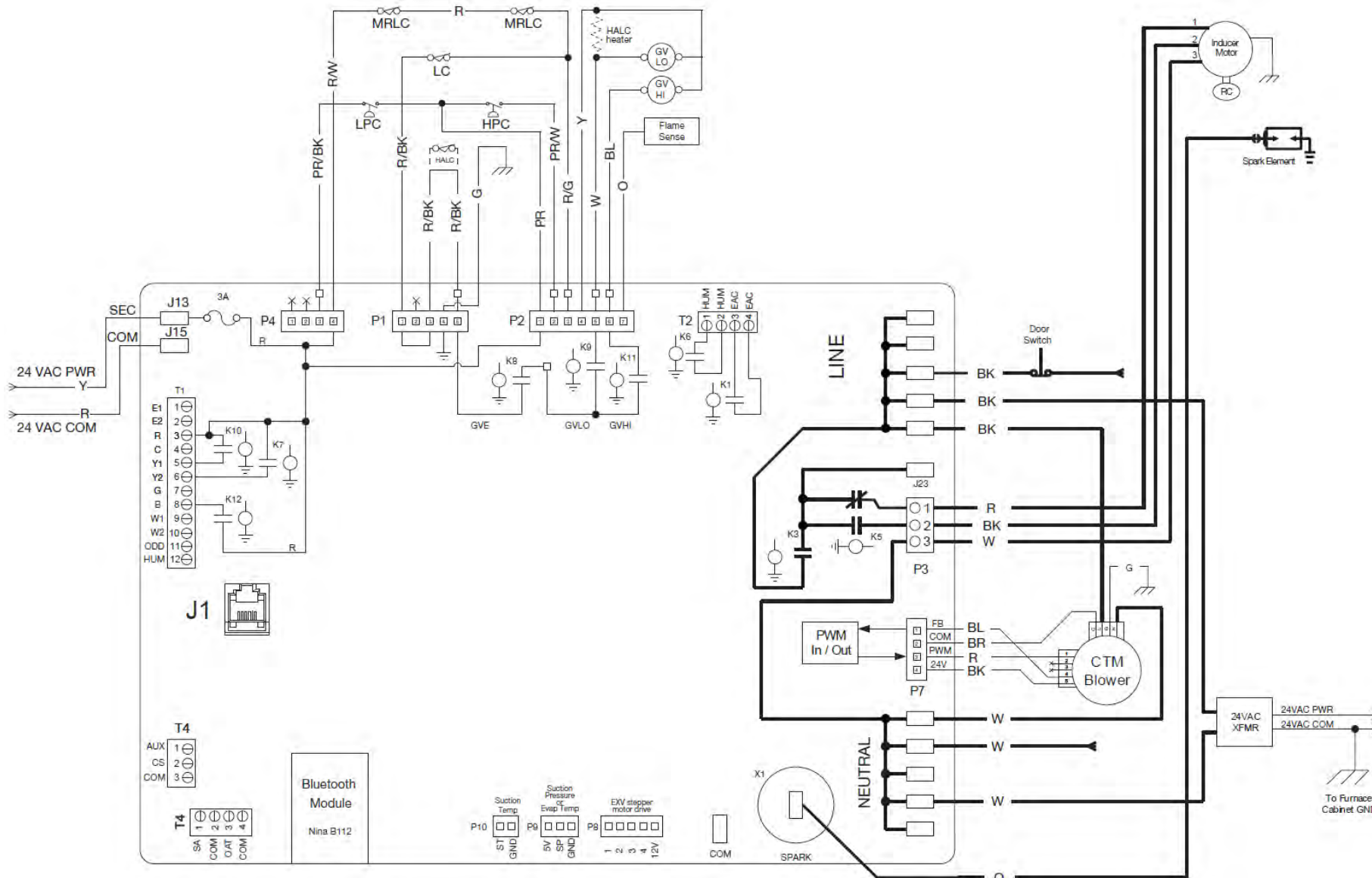

- COMPONENT CODES**
- BLWR BLOWER RELAY SWITCH
 - C COMMON
 - CC COOLING CONTACTOR
 - CT CONTROL TRANSFORMER
 - DISC DISCONNECT SWITCH
 - EAC ELECT. AIR CLEANER OUTPUT
 - FLMS FLAME SENSOR
 - FR FAN RELAY
 - FU FUSE
 - GND GROUND
 - GVC GAS VALVE COMMON
 - GVR GAS VALVE RELAY
 - HALC HEAT ASSISTED LIMIT CONTROL
 - ACR HEAT/COOL RELAY
 - HGV HIGH GAS VALVE
 - HPC HIGH PRESSURE CONTROL
 - HUM HUMIDIFIER OUTPUT
 - IBM INDUCED BLOWER MOTOR
 - IDM INDUCED DRAFT MOTOR
 - IDR INDUCED DRAFT RELAY
 - IFC INTEGRATED FURNACE CONT.
 - LC LIMIT CONTROL
 - LGV LOW GAS VALVE
 - LPC LOW PRESSURE CONTROL
 - M MAIN
 - MC MEMORY CARD
 - MGV MAIN GAS VALVE
 - MRLC MAN. RESET LIMIT CONTROL
 - NEU NEUTRAL
 - NPC NEGATIVE PRESSURE CONT.
 - PBS PUSH BUTTON SWITCH
 - PFC POWER FACTOR CHOKE
 - PL PLUG
 - PS PRESSURE SWITCH
 - RC RUN CAPACITOR
 - SE SPARK ELECTRODE
 - TM THERMISTOR
 - WS WATER SENSOR
 - WIRE NUT

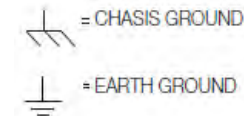

- WIRE COLOR CODE**
- BK.....BLACK
 - BR.....BROWN
 - BL.....BLUE
 - G.....GREEN
 - GY.....GRAY
 - O.....ORANGE
 - PR.....PURPLE
 - R.....RED
 - W.....WHITE
 - Y.....YELLOW



WIRING DIAGRAM – (-)962V (TWO STAGE 90+)

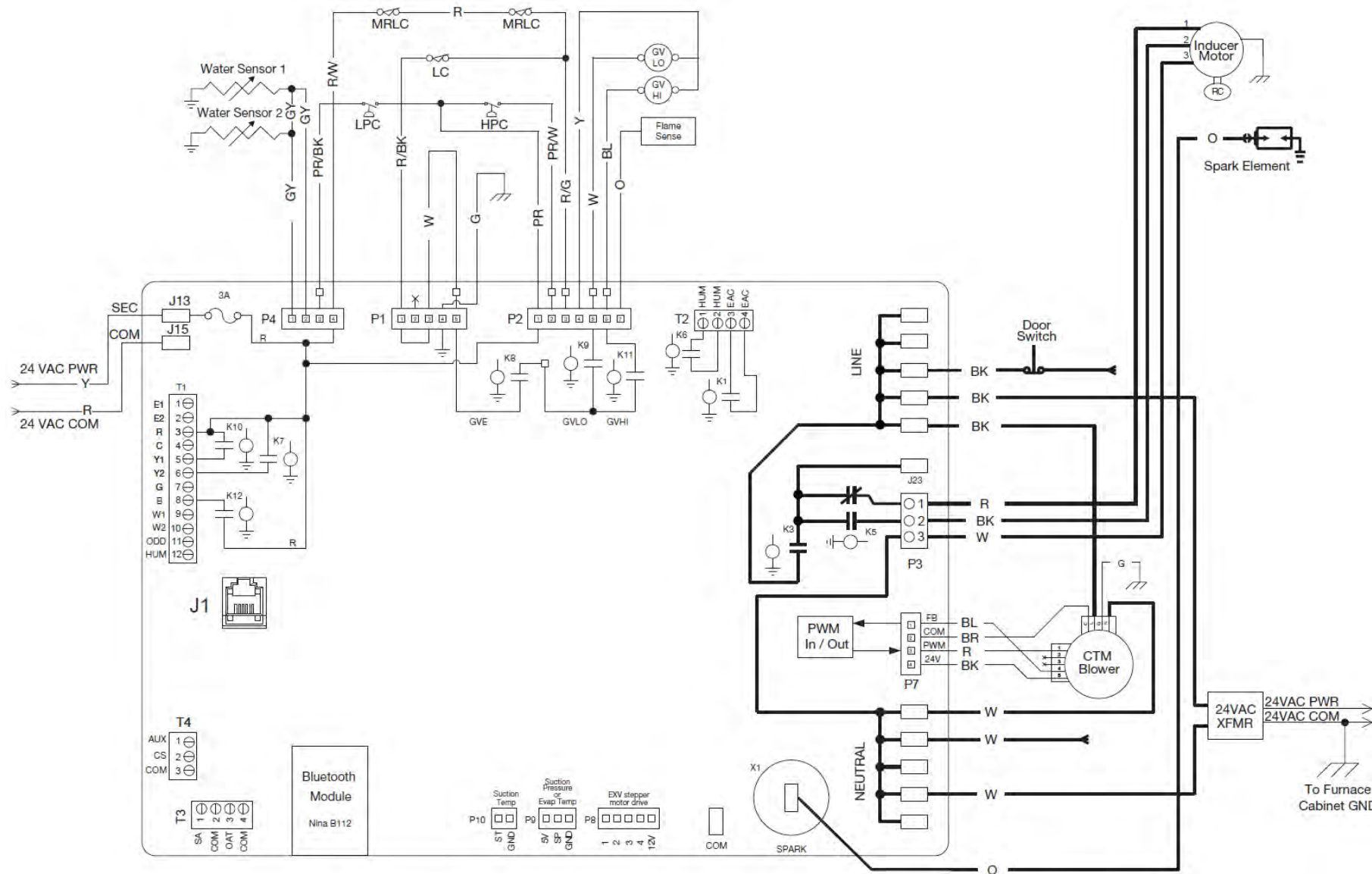

COMPONENT CODES

- BLWR BLOWER RELAY
- C COMMON
- CC COOLING CONTACTOR
- CT CONTROL TRANSFORMER
- DISC DISCONNECT SWITCH
- EAC ELECT. AIR CLEANER OUTPUT
- FLMS FLAME SENSOR
- FR FAN RELAY
- FU FUSE
- GND GROUND
- GVC GAS VALVE COMMON
- GVR GAS VALVE RELAY
- HALC HEAT ASSISTED LIMIT CONTROL
- HCR HEAT/COOL RELAY
- HGV HIGH GAS VALVE
- HPC HIGH PRESSURE CONTROL
- HUM HUMIDIFIER OUTPUT
- IBM INDOOR BLOWER MOTOR
- IDM INDUCED DRAFT MOTOR
- IDR INDUCED DRAFT RELAY
- IFC INTEGRATED FURNACE CONT.
- LC LIMIT CONTROL
- LGV LOW GAS VALVE
- LPC LOW PRESSURE CONTROL
- M MAIN
- MC MEMORY CARD
- MGV MAIN GAS VALVE
- MRLC MAN. RESET LIMIT CONTROL
- NEU NEUTRAL
- NPC NEGATIVE PRESSURE CONT.
- PBS PUSH BUTTON SWITCH
- PFC POWER FACTOR CHOKE
- PL PLUG
- PS PRESSURE SWITCH
- RC RUN CAPACITOR
- SE SPARK ELECTRODE
- TM THERMISTOR
- WS WATER SENSOR
- ⌘ WIRE NUT

WIRE COLOR CODE

- BK.....BLACK
- BR.....BROWN
- BL.....BLUE
- G.....GREEN
- GY.....GRAY
- O.....ORANGE
- PR.....PURPLE
- R.....RED
- W.....WHITE
- Y.....YELLOW



THERMOSTAT WIRING – ECONET[®]

- **NEW!** Removeable low voltage terminal block on the thermostat wiring for 2-stage furnaces
- Requires continuous 18 AWG thermostat wire.
 - Do not use phone cord to connect indoor and outdoor units. This will damage the controls.
- The EcoNet control system requires four (4) control wires for unit operation:
 - R 24 VAC
 - C 24 VAC common
 - E1 Communications
 - E2 Communications
- The EcoNet enabled air handler or furnace is equipped with a 24-volt, 40 or 50 VA transformer for proper system operation. See the wiring diagram below for low voltage wiring connections.

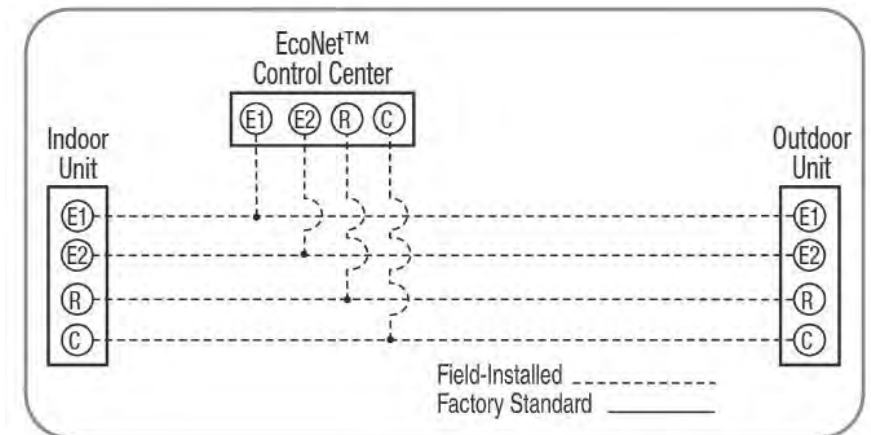



THERMOSTAT WIRING – LEGACY (24V) THERMOSTAT

- **NEW!** Removeable low voltage terminal block on the thermostat wiring
- Thermostat control wiring requires a minimum of six (6) wires for proper heat pump operation and five (5) wires for proper AC operation:
 - E1/E2 – EcoNet® communications
 - R – 24 VAC (AC/HP)
 - C – 24 VAC common (AC/HP)
 - Y1 – 1st stage compressor (AC/HP)
 - Y2 – 2nd stage compressor (AC/HP)
 - G – Fan operation
 - W1/W2 – Low/High stage gas heat operation

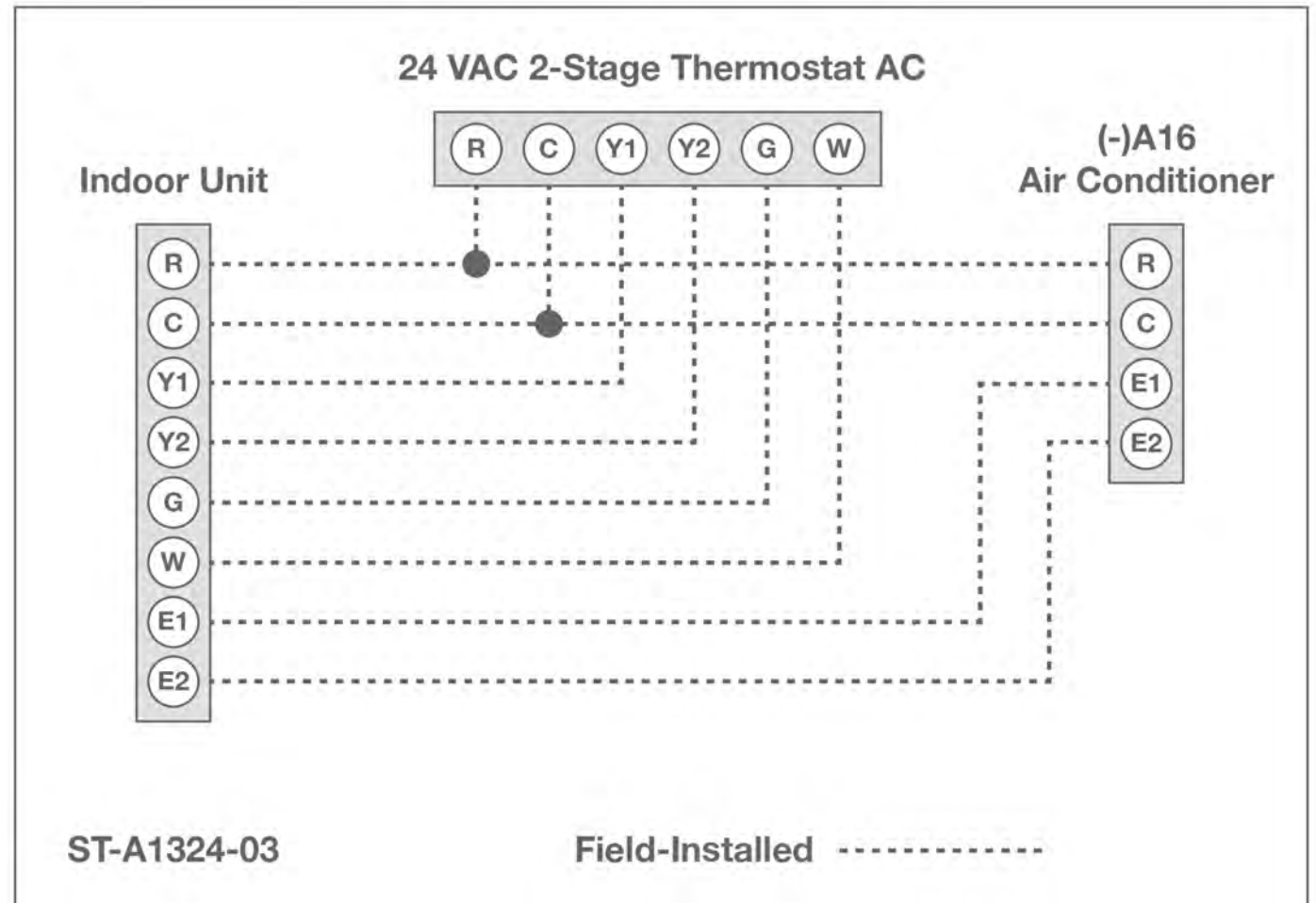



COMMISSIONING FURNACES: ECONET® THERMOSTAT

- No extra setup required
- You can further refine comfort settings. For example,
 - Blower Off Delay
 - Heat Airflow Adjust
- These adjustments can only be made at the EcoNet Smart Thermostat

Furnace Settings		
LED Display Orientation		Upflow
Furnace Blower Off Delay		90 secs.
Hi Heat Airflow Adjust		None
Lo Heat Airflow Adjust		None
G Input Fan Control		Off
Condensate Input	N.O.	Off
Aux Config	N.O.	Off

<BACK MORE>

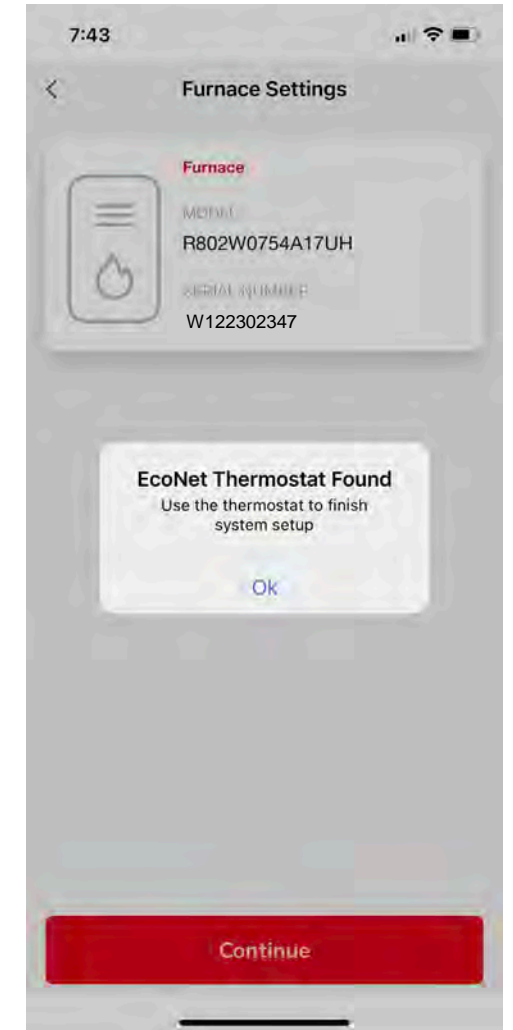



COMMISSIONING FURNACE: LEGACY (24V) THERMOSTAT

- Must set the system up using the Contractor App
 - System will detect a communicating ODU
 - System will detect a non-communicating ODU and require additional selections
 - Outdoor Unit Stages
 - Outdoor Unit Tonnage
 - System will detect standalone furnaces
- Can further refine comfort settings after system is connected
 - Heat Rise (App detects downflow model and will not display side return option.)
 - HP or Cooling Blower Off Delay
 - High Stage Heating Timer (2-stage standalone furnaces with 1-stage thermostat)
- If unit is installed, but can't be configured, the system will use the "default" model data from the board that was programmed at the factory.
 - It will be the highest nominal airflow for that unit.

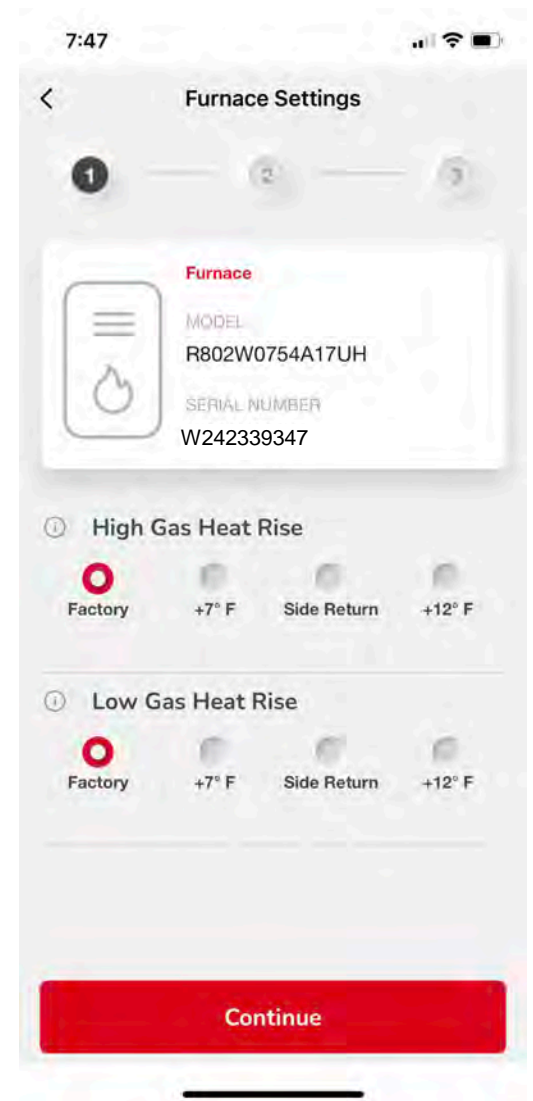



NORMAL GAS HEATING OPERATION

Upon Startup, regardless of the demand call.

- 80s furnaces light at low fire
- 90s furnaces light at high fire

Call for Heat

1. System verifies all safeties are met.
2. Once safeties are verified, the inducer will turn on and wait for the pressure switches to close.
3. When pressure switches are closed, system does pre-purge.
4. After 30s pre-purge (34s to be exact, but needs to be 30s at least), system performs ignition trial.
5. Once flame is established, the blower is energized after about 20 second delay (22s from the start of ignition trial).
6. The blower will turn on and system is now in steady state heating.
7. At the end of a heat call,
8. Inducer post purge of 10 seconds.
9. Blower off delay (default 90 seconds)





BLOWER OFF DELAYS

Blower off delay

- 90 second delay is default (gas heating)
- 45 second delay is default (cooling/HP)
- With an EcoNet® system, the EcoNet Smart Thermostat is where the settings for this are stored.
- In a legacy system, the blower off delay is controlled by the furnace.
 - When a demand (cooling or gas heating) is removed, it will go into blower off delay that was set up using the contractor app at installation.
 - Options in the contractor app
 - Gas heating: 90, 120, 150, and 180 seconds
 - Cooling: 0, 30, 45, and 60 seconds



SEQ. OF OPERATION – IGNITION TRIAL FAILS

If the system doesn't sense flame during ignition trial...

1. On a call for heat, the furnace control checks to make sure the pressure switch is open. Next the control runs the inducer for 34 seconds of pre-purge.
2. The control goes into ignition trial (gas valve(s) and spark ignitor energize). Gas valve(s) and spark ignitor energize for a max. of 7 seconds.
3. If flame is not established during this time, this ignition trial fails.
4. Control goes into inter-purge for 10 seconds.
5. After inter-purge, control attempts ignition trial (step 2) again.
6. If no flame is sensed during the ignition trial period, control goes through 10-seconds of inter-purge, and attempts ignition trial again. There are a maximum of 4 ignition trial attempts.
7. If the control fails to establish flame on the fourth ignition trial attempt, the control goes a 1-hour lock-out.



SEQ. OF OPERATION – MAIN LIMIT TRIPS

If the main limit trips while in steady state heating:

1. System will go into post-purge and blower off delay cycle
2. A main limit timer will start to count up. (main limit can reset itself)
3. If the main limit recloses and timer is <150 sec (clogged filter)
 1. Fault level is T022 during first 150 seconds.
 2. If it closes, it will go back into normal ignition cycle after the blower off delay is complete. (no lockout)
4. If it still doesn't close after 150 seconds, the alert jumps to Alarm (A022) (Dead Blower Condition)
 1. A061 (blower fault motor cannot run) gets logged simultaneously
 2. After 150 seconds, if the main limit resets, the system will go into a 1-hour gas heating lockout
 3. After lockout, the system will go into normal heating ignition cycle (if heating call is still present)
5. If the dead blower counter hits 4, the system will go into a hard lockout.
 - If a heating call is satisfied normally with no main limit trips, the dead blower counter is reset



SEQ. OF OPERATION – PRESSURE SWITCH FAILS TO CLOSE 80+

1. Normally, when the inducer turns on, it will wait for the pressure switch to close within 10 seconds.
2. 1st Pre-purge
 - If its closed or closes within a 3 seconds, it will complete the 34 second pre-purge cycle and then the ignition sequence will start.
 - If it doesn't close within 3 seconds, it will wait for the entire 34-second 1st pre-purge cycle and then move to the 2nd pre-purge cycle.
3. 2nd Pre-purge
 1. The control bumps the inducer to high stage (only 2-stage control). For 1-stage, inducer only runs at high stage by default.
 2. Will wait 14 seconds for the switch to close at high inducer speed.
 1. If it still doesn't close, it will go into a 5-min lockout.
 - Cycle power will clear the lockout.
 - Clear faults will clear the lockout
 2. If it closes, it will go back into low stage and complete 34s pre-purge, then go to ignition trial.
4. After 5-min lockout, the system will attempt to fulfill the call for heat.
 - No hard lockout.

Enhancement

- The pressure switch is no longer wired in series with the gas valve.
- An open pressure switch will be ignored if open less than 4 seconds
 - Fewer nuisance alarms/alerts for issues like wind gusts
 - If more than 4 seconds, the system will treat it as an open pressure switch (alert)



SEQ. OF OPERATION – PRESSURE SWITCH FAILS TO CLOSE 90+

1. Normally, when the inducer turns on, it will wait for the pressure switch to close within 10 seconds.
2. 1st Pre-purge
 - If its closed or closes within 3 seconds, it will complete the 34 second pre-purge and then the ignition sequence will start.
 - If it doesn't close within 3 seconds, it will complete the 34-second pre-purge and then go to 2nd pre-purge cycle
3. 2nd Pre-purge
 - If its closed or closes within 3 seconds, it will complete the 34 second pre-purge and then the ignition sequence will start.
 - If it doesn't close within 3 seconds, it will complete the 34-second pre-purge and then go a 3rd pre-purge cycle
4. 3rd Pre-purge
 - If its closed or closes within 3 seconds, it will complete the 34 second pre-purge and then the ignition sequence will start.
 - If it still doesn't close, go into a 5-min lockout.
5. After 5-min lockout, the system will attempt to fulfill the call for heat.
 - No hard lockout

Enhancement

- The pressure switch is no longer wired in series with the gas valve.
- An open pressure switch will be ignored if open less than 4 seconds
 - Fewer nuisance alarms/alerts for issues like wind gusts



TROUBLESHOOTING



FAULT CODES – ECONET® SMART THERMOSTAT

1. To view current alerts/alarms tap Menu > Service > Alerts.
2. To view past alerts/alarms, tap Menu > Settings > Installer > Alarm History.
3. Use PTS or Contractor App to view EcoNet help pages.

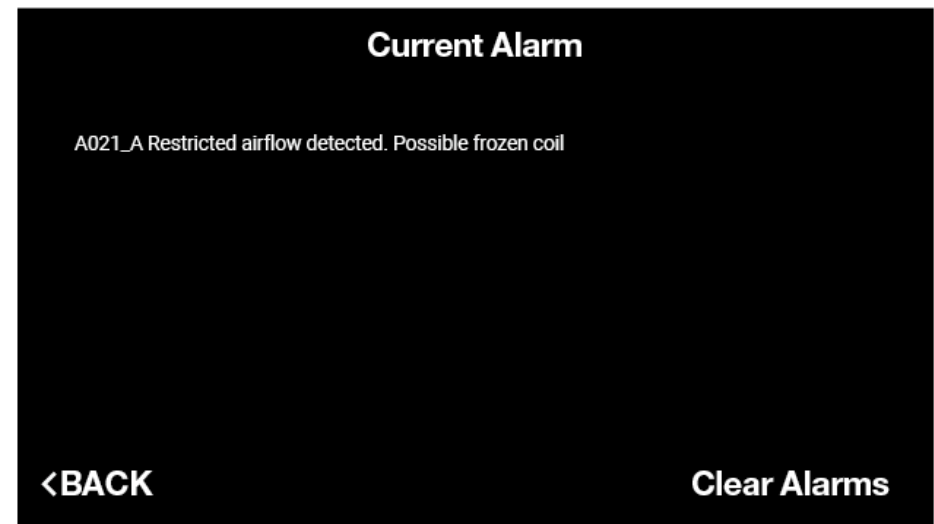
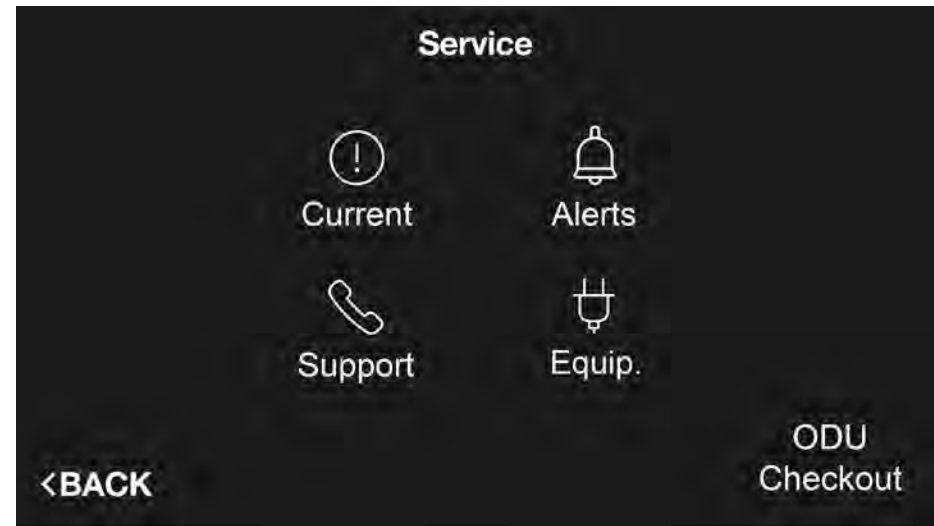



FAULT CODES – CONTRACTOR APP

1. Service > Run Diagnostics
2. Connect to the equipment
3. Active alarms and alarm history will show
4. Click on an alert/alarm icon to view help pages
 - Requires WiFi/Data to retrieve pages
 - Requires user to be logged in to view help pages
 - If using the app as a guest, help pages will not be available.

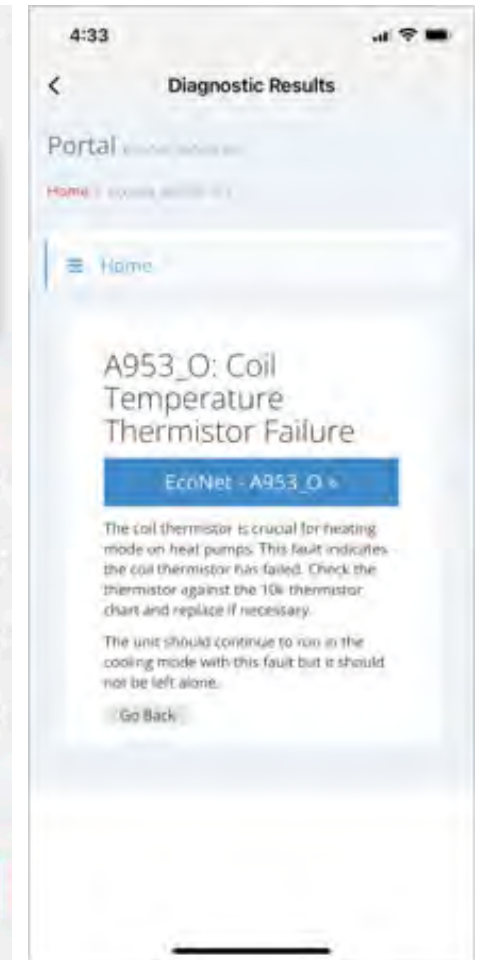
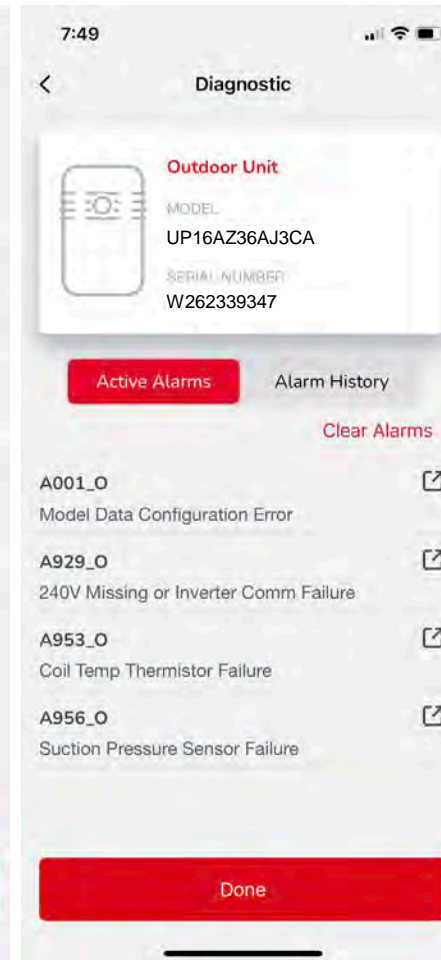
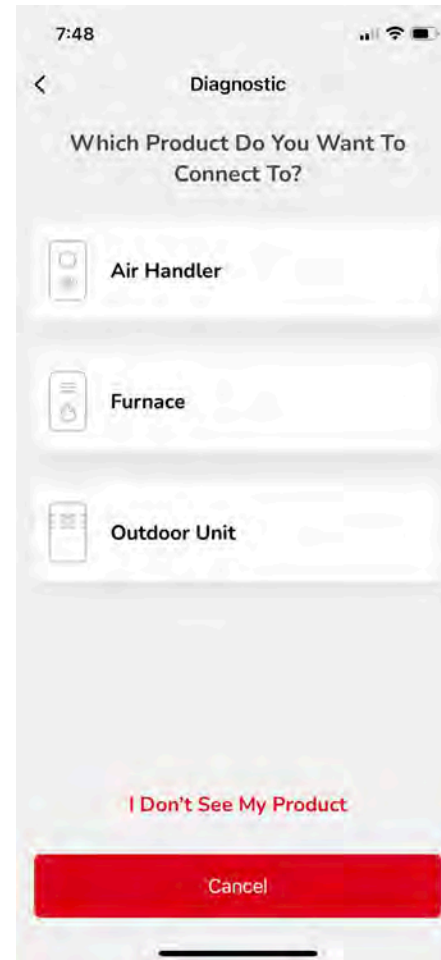



BLUETOOTH® TROUBLESHOOTING

Broken Bluetooth Antenna

- App won't show the unit in the connection options
- LEDs might still flash, but won't be able to connect unless really close to the board
- Equipment will have a help number techs can use if having trouble connecting to Bluetooth

! ATTENTION CONTRACTORS
APP REQUIRED FOR SYSTEM SETUP!

1. DOWNLOAD THE CONTRACTORS APP
Download App Here → 

2. CONNECT TO BLUETOOTH® 

FOR CONNECTION AND APP RELATED QUESTIONS,
PLEASE CONTACT CUSTOMER SUPPORT AT:
(800) 255-2388

Apple and App Store are registered trademarks of Apple Inc. Google Play is a service mark provided by Google LLC.

This device complies with Part 15 of the FCC Rules. Operation is subject to the following two conditions: (1) This device may not cause harmful interference, and (2) This device must accept any interference received, including interference that may cause undesired operation.



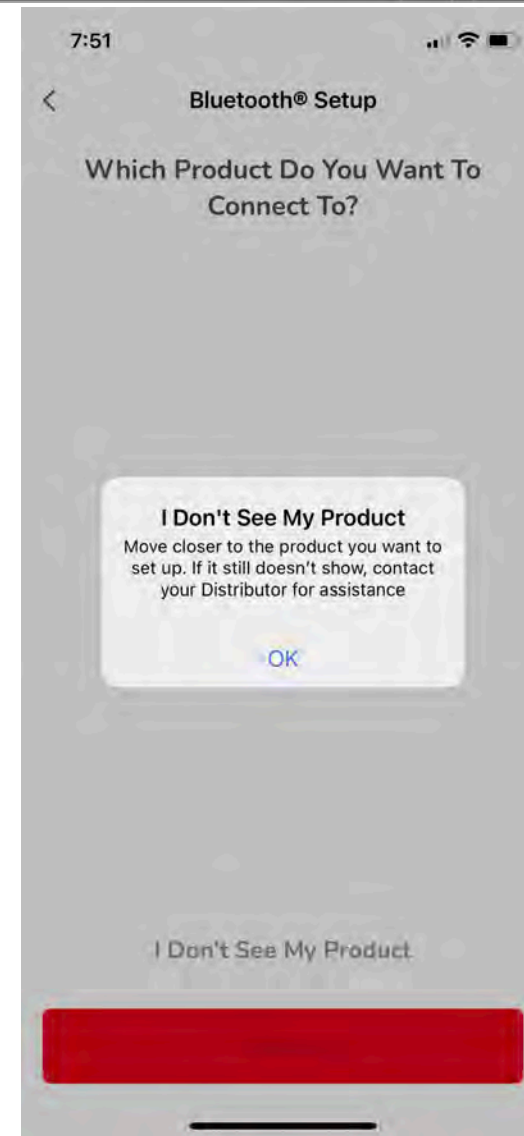

FURNACE CONTROL LEDS

LED colors

- **Green LED** – Bluetooth LED
- **Red LED** – Alarm LED
- **Amber LEDs** – Status monitor LEDs

Bluetooth® light

- Dead, no LED = not sensed in the app
- Flashing = open to connection
- Solid = connected

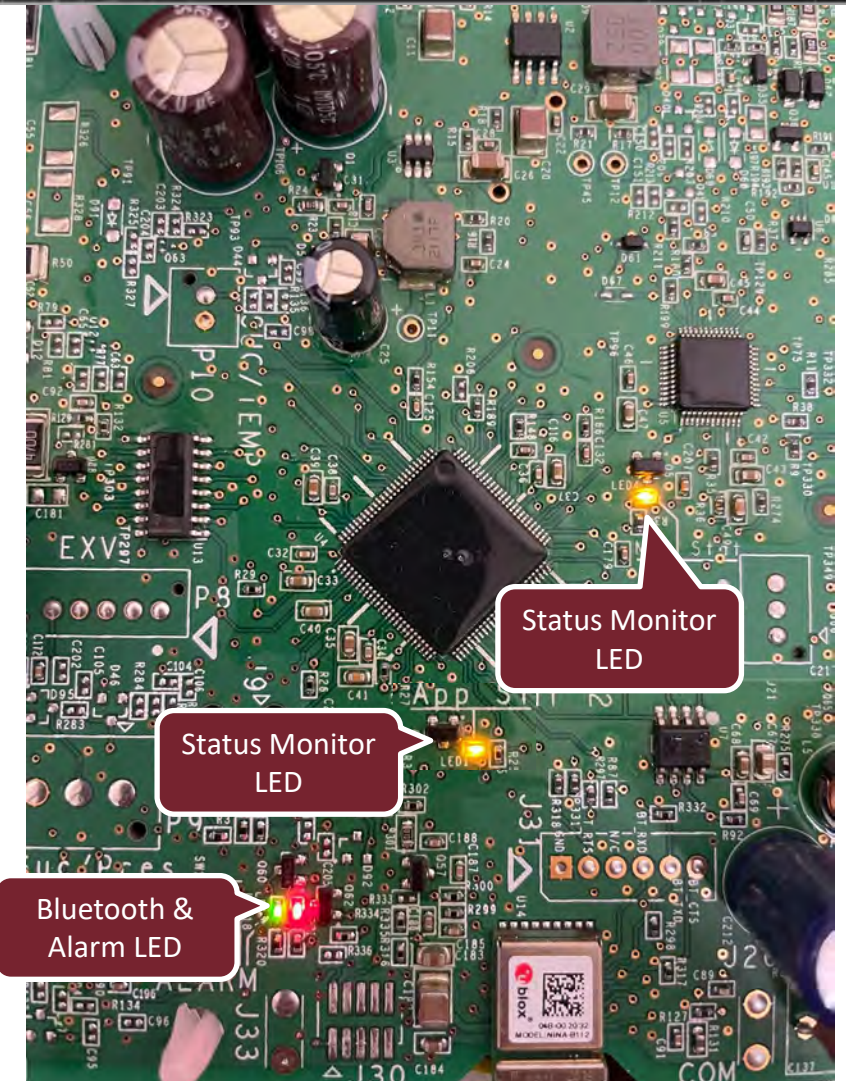



EcoNet® Smart Stat

1. From the EcoNet Smart Stat, go to Alarm History or Current Alarms.
2. If the PWM signal was lost, there will be a record of it in the Alarm History or the Current Alarms.

Contractor App

1. From the EcoNet Smart Stat, go to Alarm History or Current Alarms.
2. If the PWM signal was lost, there will be a record of it in the Alarm History or the Current Alarms.
 - See EcoNet fault codes in the Contractor App help pages or At Your Fingertips pages.

If PWM signal is lost, system will revert to constant torque mode (dictated by the model data saved on the board).

TROUBLESHOOTING THE PWM SIGNAL (CONT'D)

- The control gives a PWM to the motor for 1 – 100% torque values.
- The motor receives this signal and applies this torque.
- It sends a pulse string back to the control which gives the RPM of the motor.
- This is a feedback control loop.
- If the control does not receive the pulse string from the motor, it will go into constant torque mode (in model data).
- The control will also give an alarm if none of these things are present.
- The technician should be able to probe between Pin 1 and ground on the motor connector and measure a voltage between 1 – 24 VDC.

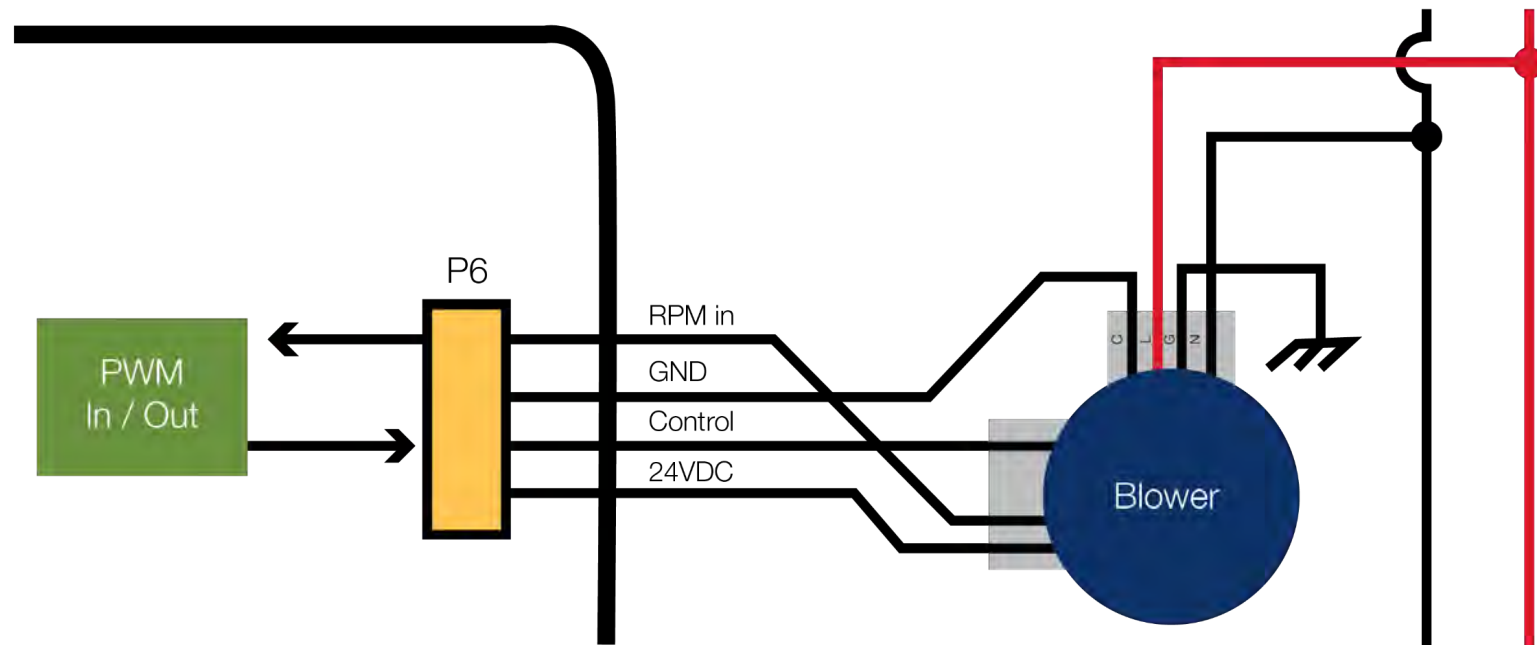



FLAME SENSE TROUBLESHOOTING

- Flame sense has to be diagnosed with the Contractor App.
- Why? This signal is now digital and no longer analog.
- You can't check micro-amps.
 - If you do, you'll trigger a false flame
 - You won't get any actual data either
- If flame sense rod must be replaced, must be routed away from high voltage wires.

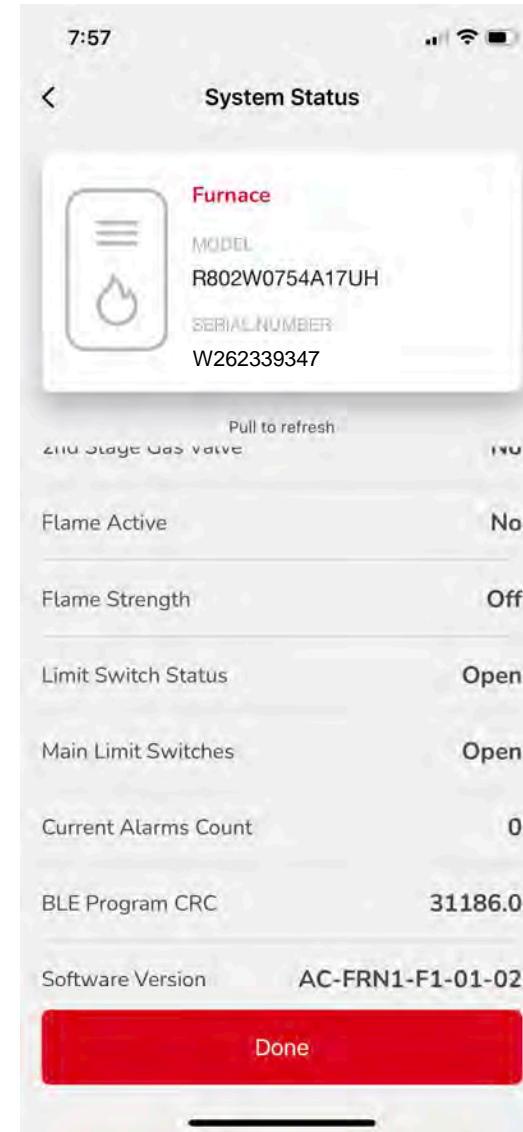



RESOURCES & FOLLOW-UP



DOWNLOADING AND INSTALLING THE CONTRACTORS APP

You can download and install the Contractor App compatible with your operating system.

The App supports iOS 13 or later and Android 7 or later.

1. Do one of the following:

- On the unit, locate a blue label with a QR code and scan it with your smartphone. Select your brand. You are redirected to the app download page.

or

- In Google Play Store or the App Store on your smartphone, search **the name of the app**.

2. Download and install the Contractor App.

**ATTENTION CONTRACTORS
APP REQUIRED FOR SYSTEM SETUP!**

1. DOWNLOAD THE
CONTRACTORS APP
Download App Here → 

2. CONNECT TO
BLUETOOTH® TECHNOLOGY

FOR CONNECTION AND APP RELATED QUESTIONS, PLEASE CONTACT
CUSTOMER SUPPORT AT: (800) 255-2388



Apple and App Store are registered trademarks of Apple Inc.
Google Play is a service provided by Google LLC.

spective owners.



- Installation Instructions
- Warranty

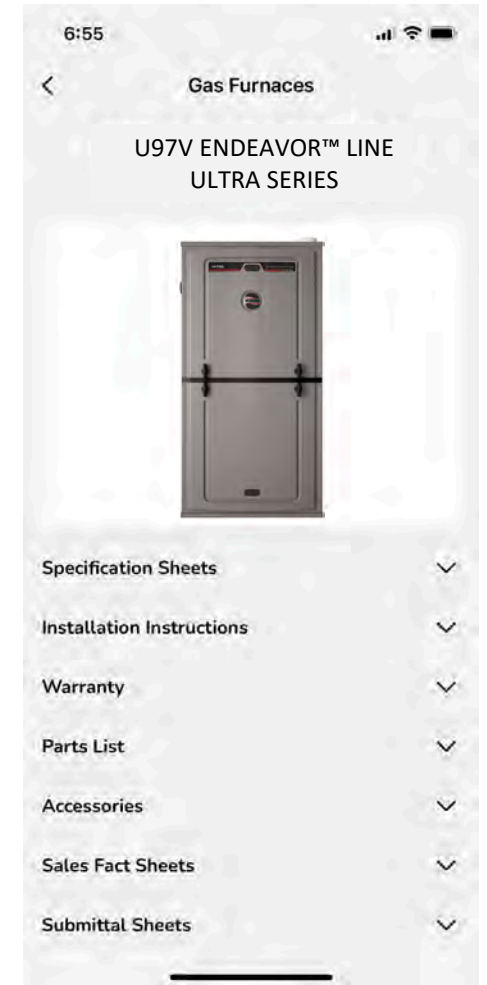
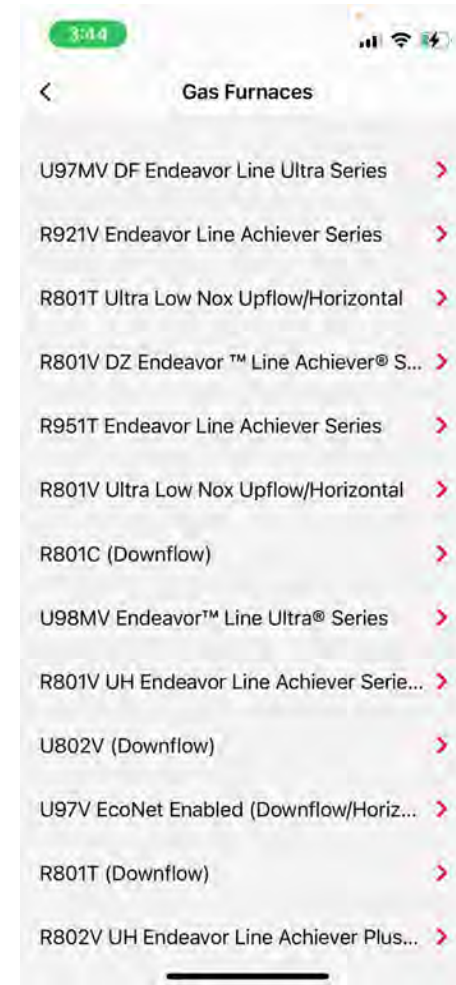
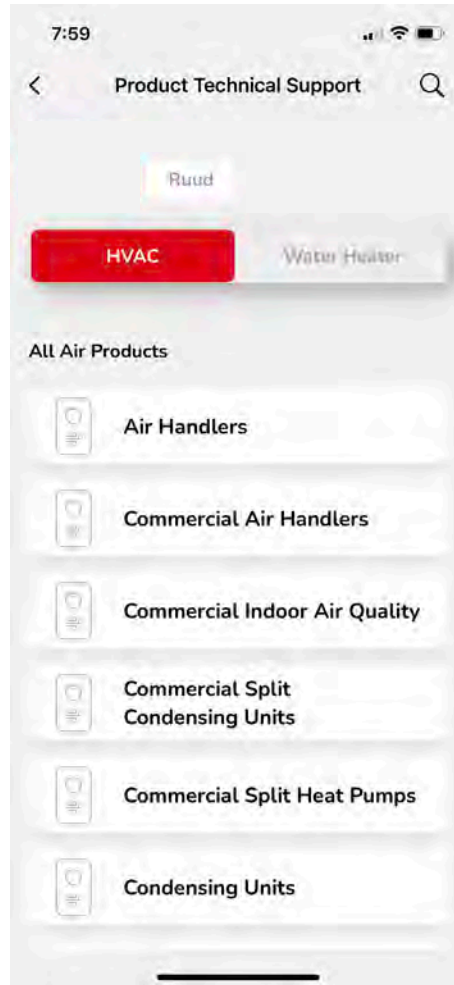



SHOW CUSTOMERS HOW YOU CAN HELP THEM LIVE MORE COMFORTABLY—AND RESPONSIBLY

Learn more about the Sustainability Standout™ seal and Ruud's commitment to sustainability: www.Ruud.com/Sustainability

Download a flyer to share with homeowners:





KEY TAKEAWAYS

1

CONTRACTOR APP IS REQUIRED

- Installation / Setup
- Diagnostic
- Service / Repair
- QR Code

2

BLUETOOTH TECHNOLOGY

- Antenna caution
- LED connectivity

3

FLAME SENSE

- No longer measurable voltage
- Digital signal
- Only able to diagnose via contractor App

4

GAS VALVE

- No longer directly wired to safeties (4 second delay)

5

HEAT KITS

- New heat kits with self-identifying plug
- Staging is now enabled
- Backwards (limited time) forwards compatible

6

AIR HANDLER

- Multi-stage (example RH2V/RH3V) can be field selectable for single stage operations
- Redundant motor technology (PWM defaulting to CT).



THANK YOU!
QUESTIONS?